

ISSN 2303-5145 (print)
ISSN 2303-5161 (online)



JOURNAL

OF FACULTY OF MINING, GEOLOGY AND
CIVIL ENGINEERING

GLASNIK
RUDARSKO-GEOLOŠKO-
-GRAĐEVINSKOG FAKULTETA

2024. YEAR/GODINA
Vol. 12/Broj 12
2024/12

Scientific-Professional Journal for Research in Fields of Science 1.5, 2.1 and 2.7 (Frascati)
Naučno-stručni časopis za istraživanje u naučnim poljima 1,5, 2.1 i 2.7 (Frascati)



ISSN 2303-5145 (Print)
ISSN 2303-5145 (Online)

PUBLISHER
Faculty of Mining, Geology and Civil Engineering, University of Tuzla

FOR PUBLISHER
Prof.dr.sc. Kemal Gutić

EDITOR-IN-CHIEF
Prof.dr.sc. Sunčica Mašić
Rudarsko-geološko-građevinski fakultet
Univerzitetska 2, 75000 Tuzla, BiH
Tel. +387 35 320 582
e-mail: suncica.masic@untz.ba, suncica.masic@gmail.com

TECHNICAL EDITOR FOR ONLINE EDITION
Prof.dr.sc. Tihomir Knežiček
Tel. +387 35 320 571
e-mail: tihomir.knezicek@untz.ba

EDITORIAL BOARD

Rejhana Dervišević
Tihomir Knežiček
Kemal Gutić
Nedim Suljić
Sejfudin Vrabac
Jelena Marković
Sunčica Mašić
Senaid Salihović
Izet Žigić
Dinka Pašić-Škripić

Izudin Bajrektarević
Omer Musić
Nedžad Alić
Kenan Mandžić
Zvezdan Karadžin
Adnan Hodžić
Ismet Gušić
Damir Zenunović
Adila Nurić
Eldar Husejnagić

INTERNATIONAL ADVISORY BOARD

Stjepan Čorić, Austrija
Radomir Folić, Srbija
Hazim Hrvatović, Bosna i Hercegovina
Ivan Vrkljan, Hrvatska
Dubravka Bjegović, Hrvatska
Biljana Kovačević-Zelić, Hrvatska
Dunja Aljinović, Hrvatska
Tarik Kupusović, Bosna i Hercegovina
Azra Kurtović, Bosna i Hercegovina
Stjepan Lakušić, Hrvatska
Oleg Mandić, Austrija
Vladimir Simić, Srbija
Rade Jelenković, Srbija

Enver Mandžić, Bosna i Hercegovina
Damir Markulak, Hrvatska
Esad Mešić, Bosna i Hercegovina
Violeta Mirčevska, Makedonija
Krzysztof Kotwic, Poljska
Esad Prohić, Hrvatska
Ahmed El Sayed, Bosna i Hercegovina
Predrag Mišćević, Hrvatska
Mirza Ponjavić, Bosna i Hercegovina
Vlastimir Radonjanin, Srbija
Danilo Ristić, Makedonija
Ljupko Rundić, Srbija
Phalguni Sen, Indija
Rade Tokalić, Srbija

DESKTOP PUBLISHING
Rešad Grbović

PRINT
Oxygen d.o.o

TOTAL PRINT
50

JOURNAL
FACULTY OF MINING, GEOLOGY
AND CIVIL ENGINEERING

Tuzla, 2024.



SYMPOSIUM

“Potentials of mineral raw materials in the life function of clean air, water and land, from the aspect of ecological and energy trends, Tuzla, April 18, 2024.”



The potential of raw mineral materials in the life function of clean air, water, and earth, from the aspect of ecological energy trends, is the name of the symposium organized by the Faculty of Mining, Geology and Civil Engineering in Tuzla. The goal was to point out the strategic mineral resources in Bosnia and Herzegovina and how to position our country in terms of research and exploitation while at the same time designing and developing high-quality ecological solutions. The goal was also to stimulate public interest in this field, especially among young people.

As part of the symposium, the publishing activity of the Faculty of Mining, Geology and Civil Engineering was promoted. Cooperation agreements were signed with IBH-HEROLD & PARTNER INGENIEURE Part mbB Germany and the Faculty of Engineering and Natural Sciences of the University of Zenica.



At the opening of the Symposium, Ms Antonella Di Sandra, Head of Operations Section for Economic Development, Natural Resources and Infrastructures, Delegation of the European Union to Bosnia and Herzegovina, gave an appropriate speech.

Ladies and gentlemen,

I am very pleased to welcome you today at this important event on critical raw materials (CRMs) in Bosnia and Herzegovina.

I wish to thank to the University of Tuzla for bringing together BiH authorities, international partners, experts, academia, businesses and CSOs. They all play an important role in defining the opportunities for BiH in the field of CRM.

I would like to open the event with a word on the EU framework on Critical Raw Materials.

The EU ambition on reaching a climate neutrality by 2050 through green and digital transition, depends (amongst other) on reliable, secure and resilient access to critical raw materials (CRMs).

Their definition as “critical” lays on their economic importance and supply risk, which can be mitigated through recycling and secondary production (i.e. more than half of EU sources of iron, zinc and platinum are recycled).

However, CRM supply chains are complex, fragile, and vulnerable to a wide range of risks, some of them we have witnessed over the past 4 years (i.e. covid pandemic and war in Ukraine).

In the meantime, the European Union has taken a range of measures to enhance security of its CRM supply in industry, research and trade.

Starting from the 2020 Action Plan for CRMs and continuing with the Critical Raw Materials Act, the EU commits to develop strategic international partnerships and provide funding to secure a diversified and sustainable supply of CRMs, which are also essential for the green and digital transition.

Namely, on 18th March this year, the Council adopted the Critical Raw Materials Act (CRMA), which aims to increase the EU domestic extraction, processing and recycling, and to ensure the diversification of supplies from third countries. As a result of that not more than 65% of the EU’s annual consumption of each strategic raw material should come from one single country.

This is the first EU act specifically regulating CRMs, and it is expected to enter in force in May (2024).

Amongst the main features, the CRMA introduces:

- clear deadlines for permit procedures for EU extracting projects;
- allows Commission and MSs to recognise strategic projects and perform risk assessment along supply chain;
- requires from MSs to have national exploration plans;
- sets benchmarks on extraction, processing, recycling and diversification of sources (i.e. 10% of annual consumption comes from local extraction of raw materials, 40% must be processed in the EU and 25% comes from recycled materials).

In addition, the European Union recognizes the significance of sustainable raw materials value chains, not only for its own development, but also to foster a mutually beneficial partnerships with non-EU countries.

So far, the EU has signed 11 Strategic Partnerships on raw materials value chains worldwide.

These partnerships also stimulate the creation of value added to the local production and moving up along the value chain, by improving processing capacities through innovation and new technology.

The EU is also keen to support relevant projects that could contribute to the diversification of supplies. However, an essential step in this direction is the identification of concrete investment opportunities that could supply the European market.

In light of this I can say there are several opportunities for Bosnia Herzegovina in potential strategic EU partnership on sustainable raw materials.

In these partnerships, the EU and BiH should aim together to promote economic development, modernize and decarbonize extractive and processing industry, foster knowledge and technology transfers, boost innovation and create new jobs through training and upskilling initiatives.

To achieve these objectives, we encourage BiH to identify potential viable projects, paving the way for joint ventures with EU countries. In this regard, the European Commission stands ready to actively foster dialogue and collaboration on these matters.

In conclusion, Bosnia and Herzegovina holds significant potential in field of critical raw materials.

However, we recognize the challenges posed by the dominance of state-owned enterprises in the mining sector and the need for a conducive and open legal and institutional framework.

Therefore, governance reforms are imperative to seize these opportunities.

I hope that today's symposium will bring new ideas and initiatives, to roll out a path towards sustainable development, economic prosperity and environmental stewardship.

Conclusions of the Symposium

1. The EU supports and finances sustainable projects for the exploitation of critical mineral raw materials in BiH, which indicates the need for BiH to develop the areas of exploration work and the opening of mines of critical mineral raw materials more intensively.
2. Where there are opportunities, direct the production of critical mineral raw materials according to EU guidelines and strategies that seek to reduce the dependence on the essential supply of mineral raw materials from China and focus more on value chains for mineral raw materials within the EU countries, and thus BiH.
3. Although the teaching syllabi at RGGF Tuzla are largely synchronized with EU decisions regarding the needs and treatment of critical mineral raw materials, it is necessary to create syllabi that would fully correspond to the exploitation and processing strategies of vital and energetic mineral raw materials in the light of the new EU strategy based on the use of mineral resources within EU countries and candidate countries.
4. Mining in Bosnia and Herzegovina should be developed according to the possibility of exploiting mineral deposits, according to the available technical options and conditions of the mineral raw materials market, by opening new mining capacities and expanding existing mining facilities, especially on metallic and non-metallic mineral deposits.
5. In investing in exploration works and the opening of mines, equal treatment of local and foreign investors, with absolute respect for domestic legislation, and informing the public about the status of investment works.
6. It is necessary to apply traditional methods of surface, underground, combined and borehole exploitation with a significant share of automation of production processes, use of IT and autonomous mining machinery and compliance with environmental norms and standards.
7. In the processes of research and exploitation of critical mineral raw materials, it is necessary to apply the recommendations of BAT (Best available techniques), which ensure a high degree of efficiency of mining operations and a high degree of compliance with environmental standards, which minimize the risk of environmental incidents.
8. It is necessary to promote in the public the need for exploration works on deposits of mineral raw materials, especially critical mineral raw materials, and benefits from the opening of mines, i.e. exploitation of mineral raw materials, using positive examples such as the opening of lead, baric and zinc mines in Vareš.
9. Intensify public performances of geological and mining experts in related fields to point out the real impact of the exploitation of raw mineral materials on the environment from a professional and scientific aspect, using examples of good mining practices worldwide.
10. Publicly warn and permanently warn the activists of the environmental movement that in their statements, they use data and information based on the scientific and professional postulates of geology and mining, and in the case of presenting inaccurate information that causes concern of the population, initiate the process of sanctioning groups, organizations and individuals in a manner appropriate to the situation.
11. It is necessary to organize gatherings of experts in geological, mining and related professions more often to exchange experience, especially in the application of new technologies, the possibility of opening new markets, training of personnel, monitoring of the strategic orientations of the EU regarding the treatment of energy resources and critical mineral raw materials.
12. Improvement of legal legislation in the field of mining.
13. Exploitation of metallic and non-metallic raw materials following international standards and norms.
14. Intensive participation in international projects.
15. Application of artificial intelligence AI (Chat GPT).



18. „The leather jump“ (eng) – „Ledersprung“ (deu)

The leather jump is a custom through which novices enter the mining profession. With a jump over a leather apron, the novice miner symbolically jumps over the mine shaft, acquires a godfather and is sworn into the profession. The leather jump is extremely important for students as much for the Faculty of Mining - Geology - Civil Engineering.

The ceremony begins with students, dressed in formal mining uniforms, going in search of the „Brucmajor“ (a person who has already been accepted into the mining fraternity, a respected figure among the students, their leader). They are looking for him around the City in various restaurants, cafes and shops, while singing traditional miner's songs ("Where is our Brucmajor", "Good luck, let's live all the miners", "From shift to shift", "From the tower", "Underground miners", etc.). When the students find the Brucmajor, they ask him to take them to the leather jump ceremony, which he initially denies (because not everyone can be a miner), but he nevertheless agrees after the young students answer his questions correctly while singing mining songs.

The second part of the ceremony is held in the hall. There are Old and Young miners – older students who have already been accepted into the family of miners and geologists, as well as engineers and professors. All of them with the song "We want the Presidium" ask that the famous, honorable, highly respected and infallible Presidium to take control of the ceremony. After the Presidium takes control of the ceremony, appoints its assistants and other functions of the ceremony, the representatives of the Old and Young Miners – students submit reports from the previous Jump. After the reports, Brucmajor appears and asks for permission to introduce young students who want to be accepted into the famous honorable mining family. After the Miners Hymn, the Old and Young Miners ask questions to the students, to test their maturity, knowledge and ability, that are the qualities they need to have, to become real miners and geologists. After that, the famous honorable Presidium announces the Jump and orders the Brucmajor to lead the young students to the leather jump. Before jumping, every single student has to introduce himself and to say his password, usually a witty joke that will accompany him during his studies and later work. Then the young student-miner jumps over a piece of cowhide, which is held by two older miners, and is symbolically accepted into the miner's family.



The Script is written for the central part of the ceremony, which contains seriousness and respect for tradition, but also humor for which the students are in charge, so that the spectators can enjoy the ceremony.

After the central ceremony, a festive program follows, with music and dinner for participants and guests.

The XVIII Leather jump was held on April 18, 2024 in the University Sports Hall of the University of Tuzla starting at 6 p.m., and the Mining Party at 8 p.m. in the restaurant of Hotel Minero.

Participants and Functions The XVIII Lether jump

Praesidium: Tihomir Knežiček

Adlatus Dexter: Sunčica Mašić

Adlatus Sinister: Jelena Marković

Honor roll: Amir Sušić, Izudin Bajrektarević, Zvonimir Bošković, Zijad Požegić, Kemal Gutić, Željko Knežiček, Sanel Nuhanović

Leather holders: Željko Knežiček i Izudin Bajrektarević

Cantor: Lejla Mulaosmanović & Choir of the High School of Music „Čestmir Mirko Dušek“ Tuzla

Contrapic dexter: Imer Mehić

Old students: Amila Subašić, Benjamin Brašnjčić, Edin Lapandić, Hamza Hasanspahić, Armin Hasić, Nihad Husić

Contrapic sinister: Albin Salkanović

Young students: Amira Demirović, Nedžida Pašić, Almir Brigić, Seid Beširević, Nadir Imamović

Brucmajor: Noris Sakić

Nobelbruc primus: Omer Fazlić

Nobelbruc secundus: Esmir Jusić

Students/jumpers : Anesa Hadžić, Adnan Bajić, Ajla Mehić, Bruno Šuvalić, Amina Hrustić, Muhamed Mehmedović, Sanina Hatkić, Muhamed Jahić, Samra Mešić, Denis Nukić



29. SUMMER UNIVERSITY OF TUZLA WORKSHOP "WASTE OR TREASURE"

The 29th Summer University Tuzla started this year on June 4, 2024. with an interactive workshop organized for university and high school students in the premises of the Faculty of Mining, Geology and Civil Engineering - Office for Climate and Sustainability. The workshop was opened by the Vice – Rector for International Relations of the University of Tuzla, Prof. dr. Vesna Bratovčić. On this occasion, the beginning of the work of the Office for Climate and Sustainability, which was established at the Faculty of Mining, Geology and Civil Engineering as part of the Erasmus+ 1FUTURE project, was solemnly marked.

This was also the first activity of the newly established hub, which aimed at education through practical work and creativity. The guiding idea behind the organization of this workshop was to give young creatives the opportunity to express their talent and contribute to the preservation of the planet in an inventive way.

During educational part, the importance of recycling was presented to pupils and students through a poster presentation, and in the first part of the workshop, participants learned about the causes and repercussions of climate change through the interactive educational game "Climate Fresk". In the second part of the workshop, the students of Mixed Vocational School of Construction and Geodesy, Tuzla, with the support of their teacher-mentor, created art from waste, showing their talent by transforming seemingly useless materials into useful and beautiful items.

All participants were presented with certificates of participation and modest gifts, and their creations will be exhibited in the premises of the University of Tuzla.





Tuzla Summer University
GEOTERMALNA ENERGIJA – RESURSI I ISKORIŠTENOST
 RGGF Tuzla, 05.06.2024
 10:00 – 14:00 h

Vrijeme	Idočaj/predavač	Institucija	Tematika
10:00 – 10:25	Dr. sc. Saifed Nuharević	RGGF Tuzla	Uvodne riječi i pozdravne prezentacije i diskusija
10:25 – 10:35	Dr. sc. Zvonimir Božićević	Prof. Univerzitate u Banjoj Luci u gostima	Spektralizacija i resursi OT na području
10:40 – 11:00	Mario Jukić	RGGF Zagreb	Geotermalni resursi i testiranje i hidrotermalno testiranje
11:05 – 11:25	İbrahim Geymen	NRG Vizek Plus AB	Geotermalni resursi i testiranje
11:30 – 11:50	Dr. sc. Donatko Vlainić	RGGF Zagreb	Geotermalni resursi i testiranje: resursi i iskorisćenost hidrokarbonata?
11:50 – 12:05	Kafica i posuda		

29. SUMMER UNIVERSITY OF TUZLA

GEOTERMALNA ENERGIJA – RESURSI I ISKORIŠTENOST

According to the program of the 29th Summer University in Tuzla - LJUT 2024 Geothermal energy Tuzla Summer University, expert lectures and panel discussion "Geothermal energy - resources and utilization" were held at the Faculty of Mining, Geology and Civil Engineering, from 10 a.m. to 2 p.m.

Professional planning resulted in high-quality conclusions and suggestions for the function. Unused new sources of energy. The potential of this energy in the broader region of the Tuzla Canton was also pointed out.

In addition to students, teachers and associates, colleagues from abroad also participated. One of the focuses of the panel discussion is more intensive cooperation in cross-border research with Partners from Europe.

The possibility of applying new nanotechnologies, artificial intelligence, and modern solutions in environmental engineering to exploit this resource was pointed out. This event is dedicated to the Day of Environmental Protection in Šjet, and participants are free of charge. Committed to sustainable development, the shadow of climate change with the acceptance of ecological messages. The faculty is dedicated to educating future engineers in all study programs at the Mining Department, and the Faculty of Geology and Civil Engineering is responsible for environmental protection.

CONTENT

Rusmir Razić, Nedžad Alić MODELING OF COAL-BASED COMPOSITE BRIQUETTES IN ORDER TO REDUCE SULFUR EMISSIONS INTO THE ATMOSPHERE.....	1
Ekrem Bektašević, Hrvoje Antičević, Kemal Gutić, Denijel Sikira RECYCLING OF MATERIALS FROM THE EXCAVATION OF THE "POČITELJ" TUNNEL AND INCORPORATION OF THE OBTAINED PRODUCTS IN THE TUNNEL THROUGH CONCRETE AND BLINDING LAYER.....	12
Mujo Valjevac, Ekrem Bektašević, Kemal Gutić, Noris Sakić, Denijel Sikira EXPLOITATION AND PROCESSING OF TECHNICAL STONE FROM QUARRIES PLJEŠEVAC NEAR KISELJAK.....	23
Tihomir Knežiček BENCH HIGHT AND SLOPE ANGLE ON LITHIUM ORES OPEN PIT MINES.....	30
Dinka Pašić-Škripić, Izet Žigić, Đana Zimić HYDROGEOLOGICAL CHARACTERIZATION AND GENESIS OF MINERAL WATER "TESANJSKI KISELJAK".....	38
Dinka Pašić-Škripić, Adnan Terzić, Amir Jahić, Meris Hajdarević HYDROGEOLOGICAL RESEARCH AND TERRAIN CHARACTERIZATION ON A SECTION OF ROAD 2B SARAJEVO-FOČA, AREA OF FBiH	45
Jelena Marković, Refik Kurbašić , Zvezdan Karadžin, Edisa Nukić ANALYSIS AND REMEDIATION OF ENDOGENOUS FIRE AT LONGWALL TOTAL COAL THICKNESS MINING OF THE MAIN COAL SEAM IN RASPOTOČJE MINE OF ZENICA BROWN COAL MINES.....	52
Šefik Sarajlić, Omer Musić MECHANISED COAL EXPLOITATION IN THE "BREZJE" PIT OF THE "DJURDJEVIK" BROWN COAL MINE.....	65
Jasmin Jamaković, Sunčica Mašić FUEL CONSUMPTION OF BELAZ DUMPERS AND CARBON DIOXIDE EMISSIONS USING THE EXAMPLE OF OPEN PIT 'TURIJA' OF THE BROWN COAL MINE BANOVIĆI.....	77

MODELING OF COAL-BASED COMPOSITE BRIQUETTES IN ORDER TO REDUCE SULFUR EMISSIONS INTO THE ATMOSPHERE

Rusmir Razić¹, Nedžad Alić²

ABSTRACT

The tendency to abolish, to obtain heat from coal in order to reduce atmospheric pollution, leads to the closure of coal deposits. The alternative for obtaining heat, especially in the category of heating smaller residential buildings, with wood pellets, although acceptable from an ecological point of view, has its drawbacks, if one takes into account the scale of the required amount of energy and the role of the forest in purifying the air. Wood pulp and coal as basic energy carriers have hydrocarbon compounds. So, in both cases CO_x and NO_x gases appear as gaseous products. The difference is in their scale. Unlike wood, coal also contains sulfur compounds, which makes it an environmentally unacceptable fuel. By adding a certain amount of wood pulp and additives to the coal mass, in this work, pyrophyllite shale, the impact on the energy and ecological aspects of heat release of such a complex fuel mixture was investigated. The ecological aspect is accentuated through the release of sulfur from coal. The mixture was subjected to the briquetting process, and the obtained samples were tested with relevant parameters, primarily the obtained lower heat value and sulfur content (SO_x) in these products. The obtained results are very optimistic with both parameters mentioned above and can be a guide for further research for this idea.

Key words: coal, wood sawdust, briquette, calorific value, sulfur, ecology.

1. INTRODUCTION

The basis of the research problem is reflected in the question: does stopping (banning) the use of coal in a specific group of consumers completely solve the problem of air pollution at the local and global level. Coal, as an energy source, is used repeatedly, and among other things, in less developed countries, a significant amount is used to heat smaller residential units. On the other hand, there is an expressed tendency to abolish, to obtain heat from coal in order to reduce atmospheric pollution, which in turn leads to the closure of coal deposits. The alternative for obtaining heat, especially in the category of heating smaller residential buildings, with wood pellets, although acceptable from an ecological point of view, has its drawbacks, if one takes into account the scale of the required amount of energy and the role of the forest in purifying the air.

The most common solution offered as a replacement for coal in the aforementioned category is biomass, primarily wood or its pellets as a finished energy product. Although this mass during combustion has a significant reduction in the emission of primary gases that affect the reduction of air pollution, it is necessary to take into account the fact that the primary improvement can consequently and in the long term have a completely different result. Namely, the excessive exploitation of wood mass reduces the total amount of forest wealth, which in turn represents a natural "filter" of air, so the forest is said to be the lungs of the Earth. Therefore, the hypothesis of replacing the type of energy source put forward in this way does not give certainty in obtaining a good result of reducing pollution and impact on general climatic conditions.

The topicality of the research problem is the consideration of one of the possibilities of using coal as an energy source with reduced environmental risk (impact on the environment).

¹ MA in mining engineering, RMU Gračanica, Bosnia and Herzegovina

² Associate professor, Faculty of mining, geology and civil engineering University of Tuzla nedžad.alic@untz.ba

The aim of the research is:

- Obtain a composite coal pellet with a reduced emission of pollutants into the atmosphere,
- Reduce the consumption of wood mass for the heating needs of smaller consumers,
- Ensure the continuation of coal exploitation with acceptable ecological standards,
- By modulating the content and type of coal additives when making briquettes, it can significantly influence, during combustion, the reduction of emission gases into the atmosphere.

2. BASICS, METHODS AND MATERIALS

The basic postulates of the hypothesis are related to two processes: the burning of solid fuels and the preparation or physical form of the combustible mass.

The equipment used for all actions during the research and the applied standard are as follows: - Preparation of input components and preparation of briquettes: crushing of materials: jaw and hammer laboratory crusher, balance of accuracy 0.01 gram, type dryer, laboratory shaker with a series of sieves with square opening (mm), laboratory homogenizer and laboratory extruder press for making briquettes. -Measuring procedures and devices for establishing the parameters of the obtained experimental briquettes: elemental analysis of input components and experimental briquettes was done with an elemental analyzer EA3000, and the heat value was determined with a calorimeter system C 5000 (tables 2, 3, 4 and 5).

Coal sample: the sample was taken from the "Kotezi" coal deposit in the north-western part of the Bugojan coal basin, in a total amount of 60 kg, in the field, from the layer on the surface of this deposit, and was subjected to comminution while at the same time determining the parameters of coarseness reduction on individual laboratory devices, up to a grain size of 1 mm. Sample of sawdust: a sample of pine sawdust weighing 20 kg was taken from the sawmill "Bunta" in Bugojno. Pyrophyllite sample: a crushed sample of the purple variety of pyrophyllite shale from Parsović was used for the tests in the amount of 5000 g. The binder suspension used to make all experimental types of briquettes in this research was a 10% starch solution, type H, manufactured by Helios Domžale, R. Slovenia, in water.

2.1 Research methods

The research model is based on the following principle:

- determination of characteristic or representative (key) indicators in research;
- determination of sample processing methods, namely:
 - a) method of preparing samples for tests,
 - b) selection of methods of laboratory tests,
- interpretation and processing of research results,
- research conclusion.

2.1.1 Representative research indicators

Representative indicators of the research are: the lower heating value of briquettes without moisture, the content of total, fuel and darkness in the ash.

2.1.2 Test procedure

For the previously described materials, the elements of the composition of individual briquettes and the procedures for obtaining them in laboratory conditions have been set. In accordance with the aim of the research, it was decided to produce five briquettes with different content, in which the emphasis is on the variable content of additives, while maintaining the same amount of fuel constituents. In this connection, the following relations were formed, with the associated markings: briquette A1: whose content is 100% coal, weight 2000 g, briquette A2: whose content is coal in a mass of 1400 g and wood sawdust in a mass of 600 g, briquette A3: whose coal content in the mass of 1400 g and wood sawdust in the mass of 600 g and pyrophyllite in the mass of 40 g, briquette A4: whose content is coal in the mass of 1400 g and wood sawdust in the mass of 600 g and pyrophyllite in the mass of 120 g, briquette A5: whose content is coal in the mass of 1400 g and wood sawdust weighing 600 g and pyrophyllite weighing 200 g, and the sample of

coal used in making these briquettes is marked with the code A0. In the procedure of making individual briquettes, the total mass content of the components is given in table 1.

Table 1. Mass content of individual components in the total sample of individual briquettes

No.	Type of input component	Mass, g				
		A1	A2	A3	A4	A5
1.	sawdust	0	600	600	600	600
2.	coal	2000	1400	1400	1400	1400
3.	pyrophyllite	0	0	40	120	200
4.	starch	1,89	1,28	1,49	1,57	1,65
In total		2001,89	2001,28	2201,65	2121,57	2201,65

The added amount of suspension enabled the next stage, briquetting in an extruder press with a single hole diameter of 6 mm. The obtained green briquettes were air-dried, which completed the laboratory procedure of obtaining briquettes.

The very appearance in the outer shell, but also in the cross-section of the pellet, reflects the characteristics of the components from which it is built. Briquettes obtained from coal give a finer, smoother structure on the outer shell of the briquette cylinder, they are more homogeneous, as can be seen in the general physical sense in Figure 1. Observing, the cross-section of individual briquette mixtures, which is also shown in Figure 1, clearly in the structural characterization, individual parts of the various components that make up this composite can be observed.

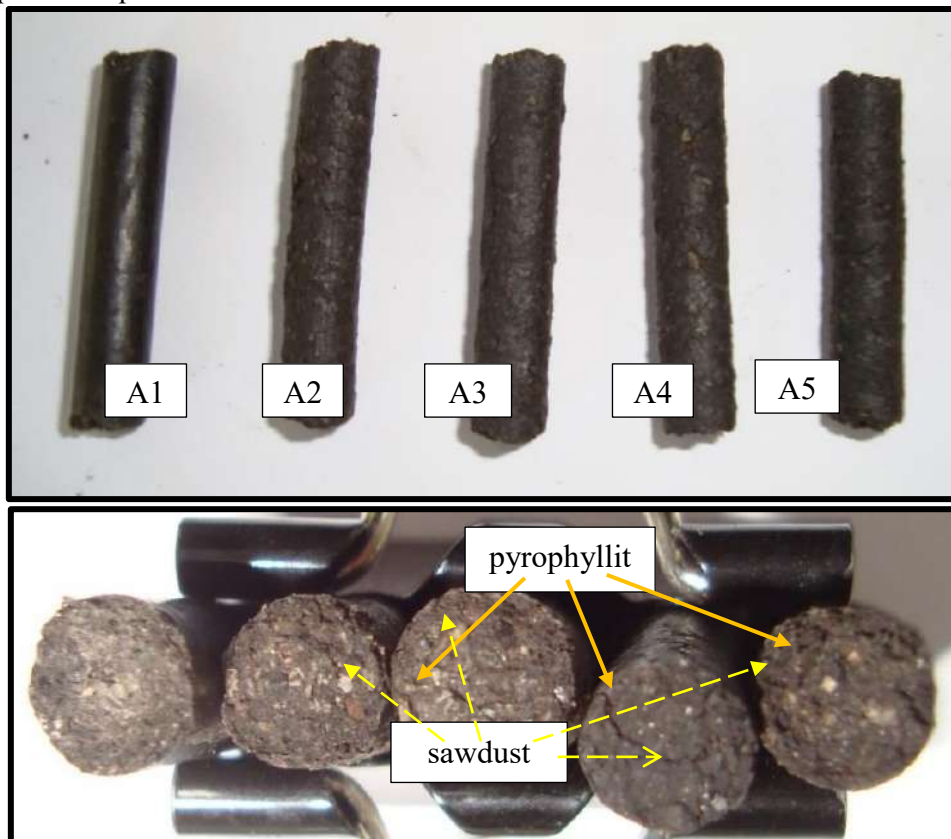

Figure 1. Structural appearance of the briquette and its cross-section

In a general physical sense, the obtained briquettes have satisfactory strength, which can satisfy all conditions of manipulative operations in their use. It is also clear that the briquettes are very hydroscopic, and that they significantly lose their mechanical characteristics when the humidity increases, up to their complete destruction.

3. RESEARCH RESULTS

Table 2, shows the summary results of elementary and technical analysis of coal, and pine sawdust, used as a supplement to coal, used in this research to make briquettes.

Table 2. Results of technical and chemical analysis of coal (sample A0) and pine sawdust, used in making briquettes and tested in RGH Kakanj, without moisture

Type of analysis	Units	Method	without moisture	
			COAL A0	SAWDUST
Ash	%m/m	BAS ISO 1171:2012	29,56	8,04
Combustible substances	%m/m	INS 80625200:2019	70,44	91,96
Volatile substances	%m/m	BAS ISO 5071-1:2014 ; BAS ISO 562:2012	44,87	78,99
Coke	%m/m	INS 80625201:2019	55,13	21,01
Cfl _k	%m/m	INS 80625201:2019	25,56	12,95
Total carbon	%m/m	BAS ASTM D 5373:2016	46,17	48,96
Hydrogen	%m/m	BAS ASTM D 5373:2016	2,92	7,2
Nitrogen	%m/m	BAS ASTM D 5373:2016	0,8	0,15
Oxygen	%m/m	ASTM D 3176:2015	18,91	35,62
GTV	kJ/kg	BAS ISO 1928:2010	17402	18588
DTV	kJ/kg	BAS ISO 1928:2010	16800	17473
Sulfur total	%m/m	BAS ISO 334:2015	3,06	0,02
Sulfur in ash	%m/m	ASTM D 1757:1996	1,42	0
Sulfur fuels	%m/m	INS 80625211:2019	1,64	0,02

The value of the characteristic parameters of the solid residue (ash) of coal combustion and wood sawdust tested in the laboratory of RGH Kakanj and the silicate analysis of pyrophyllite schist are given in table 3.

Table 3. Results of chemical analysis of pyrophyllite schist and coal ash and sawdust

Type of analysis	Method	Units	Coal A0	Sawdust	Pyrophophyllite schist
Content SiO ₂	BAS 1009:2003	%m/m	36,58	55,88	65,10
Content Fe ₂ O ₃	BAS 1011:2003	%m/m	16,5	2,69	1,65
Content Al ₂ O ₃	BAS 1013:2003	%m/m	11,64	8,61	18,38
Content CaO	BAS 1014:2003	%m/m	12,54	13,89	2,70
Content MgO	BAS 1015:2003	%m/m	5,34	8,44	1,49
Content SO ₂	BAS 1018:2003	%m/m	15,60	1,14	0,58
Content TiO ₂	BAS 1012:2003	%m/m	0,22	0,16	0,08
Content Na ₂ O	ASTM D 6349:2013	%m/m	0,29	5,11	0,23
Content K ₂ O	ASTM D 6349:2013	%m/m	1,29	4,09	1,77
Content MnO	-	-	-	-	0,02
Content P ₂ O ₅	-	-	-	-	0,06
Content CO ₂	-	-	-	-	4,04
Content KH ₂ O	-	-	-	-	3,90
Suma			100,00	100,00	100,00

Table 4. Results of technical and chemical analysis of briquettes from experiments, without moisture

Type of analysis	Units	Method	Samples of briquettes without moisture														
			A1	A2-1	A2-2	A2-3	A3-1	A3-2	A3-3	A4-1	A4-2	A4-3	A5-1	A5-2	A5-3		
Ash	%m/m	BAS ISO 1171:2012	25,36	20,73	20,63	20,77	21,25	21,24	20,94	24,89	24,62	24,95	25,92	24,88	25,86		
Combustible substances	%m/m	INS 80625200:2019	74,64	79,27	79,37	79,23	78,75	78,76	79,06	75,11	75,38	75,05	74,08	74,42	74,14		
Volatile substances	%m/m	BAS ISO 5071-1:2014 ; BAS ISO 562:2012	45,28	54,31	54,17	54,42	54,39	54,41	54,23	53,13	53,12	53,12	51,37	51,94	51,74		
Coke	%m/m	INS 80625201:2019	54,72	45,71	45,83	45,58	45,61	45,59	45,77	46,94	46,94	46,88	48,63	48,06	48,26		
Cfl _k	%m/m	INS 80625201:2019	29,36	24,96	25,21	24,81	24,36	24,35	24,83	22,01	22,28	21,93	22,78	22,48	22,44		
Total carbon	%m/m	BAS ASTM D 5373:2016	49,14	50,89	50,93	50,79	50,31	50,31	50,48	47,99	48,14	47,95	49,76	49,95	49,61		
Hydrogen	%m/m	BAS ASTM D 5373:2016	3,13	3,31	3,32	3,32	3,29	3,3	3,31	3,13	3,16	3,13	3,11	3,12	3,1		
Nitrogen	%m/m	BAS ASTM D 5373:2016	0,87	0,92	0,92	0,92	0,93	0,93	0,93	0,87	0,88	0,87	0,87	0,87	0,88		
Oxygen	%m/m	ASTM D 3176:2015	19,73	22,61	22,66	22,57	22,53	22,52	22,61	21,54	21,59	21,55	19,22	19,34	19,38		
GTV	kJ/kg	BAS ISO 1928:2010	18605	18958	18978	18945	18769	18776	18851	17884	17967	17861	18803	18868	18704		
DTV	kJ/kg	BAS ISO 1928:2010	17961	18276	18295	18261	18091	18097	18169	17239	17316	17216	18163	18226	18065		
Sulfur total	%m/m	BAS ISO 334:2015	3,29	2,2	2,21	2,29	2,49	2,48	2,53	2,71	2,77	2,69	2,53	2,55	2,57		
Sulfur in ash	%m/m	ASTM D 1757:1996	1,47	0,66	0,67	0,67	0,81	0,8	0,8	1,14	1,15	1,14	1,41	1,4	1,4		
Sulfur fuels	%m/m	INS 80625211:2019	1,82	1,54	1,54	1,62	1,68	1,68	1,73	1,57	1,62	1,55	1,12	1,15	1,17		

For all briquettes obtained according to the described procedure and recipes, measurements of indicators of elemental and immediate analysis were performed. Both analyzes were performed on three separately taken samples from each mixture made according to the recipe, i.e. type of briquette, for samples with gross moisture, with moisture in the analytical sample and without moisture, the results of which are given in table 4, in table 5 are the results of the silicate analysis of briquette ash.

Table 5. Results of chemical analysis of briquettes

Type of analysis	Method	Units	Chemical analysis of ash of briquette samples												
			A1	A2-1	A2-2	A2-3	A3-1	A3-2	A3-3	A4-1	A4-2	A4-3	A5-1	A5-2	A5-3
Content SiO ₂	BAS 1009:2003	% m/m	37.64	49.43	49.59	49.37	41.85	41.51	41.65	47.07	47.16	46.88	38.59	38.22	38.47
Content Fe ₂ O ₃	BAS 1011:2003	% m/m	13.57	16.37	15.97	15.97	15.57	15.78	15.57	13.17	13.38	13.13	15.77	15.58	15.57
Content Al ₂ O ₃	BAS 1013:2003	% m/m	14.34	10.84	11.16	10.84	11.48	11.79	11.79	9.56	9.88	9.88	14.03	13.38	13.7
Content CaO	BAS 1014:2003	% m/m	13.4	10.25	10.2	10.3	12.1	12.05	12.05	11.6	11.4	11.65	12.2	12.55	12.4
Content MgO	BAS 1015:2003	% m/m	4.3	2.95	2.9	3	6.8	6.9	6.7	3.6	3.7	3.6	3.05	3.25	3.1
Content SO ₃	BAS 1018:2003	% m/m	14.72	8.22	8.31	8.18	9.68	9.79	9.74	11.73	11.66	11.7	13.94	14.03	13.86
Content TiO ₂	BAS 1012:2003	% m/m	0.25	0.3	0.27	0.28	0.21	0.23	0.21	0.25	0.23	0.25	0.21	0.24	0.22
Content Na ₂ O	ASTM D 6349:2013	% m/m	0.331	0.281	0.266	0.271	0.255	0.261	0.249	0.364	0.333	0.341	0.247	0.259	0.239
Content K ₂ O	ASTM D 6349:2013	% m/m	1.291	1.279	1.265	1.277	1.207	1.211	1.205	1.305	1.297	1.242	1.202	1.218	1.199

4. DISCUSSION OF THE OBTAINED RESULTS

The analysis of the obtained test results in this paper must take into account the statements of expected deviations in the calculations of the obtained and experimentally measured values of the relevant research indicators. In addition, the following two processes that have a significant impact on the process of obtaining the sample in its final form (briquettes) in the different variants provided for in this research should be mentioned:

- the first refers to standardized methods of determining the parameters of representative quantities of materials that enter the composition of the target composite, for example from the total quantity obtained by homogenization of the material sample, the heat value in the calorimeter (as well as all other indicators) is determined at the quantity of 1 gram, knowing that the materials used are extremely inhomogeneous,
- the second, although accurately measured quantities of constituents in the final form of briquettes (coal, sawdust and pyrophyllite) are introduced into the process, it is almost impossible to distribute these components, regardless of their dosing and mixing method, evenly, in such a way that they are present in each part of the obtained briquette and in all the obtained briquettes.

The problem arises when one wants to define parameter values in measuring devices, which generally take the minimum amount of mass in the analysis. This minimum amount is actually obtained through the laboratory procedure of determining a representative sample. Considering the physical characteristics of the briquettes (shape, state of dimensions, etc.), it is very difficult to obtain a relevant representative sample. The problems just mentioned lead us to first perform a theoretical analysis of the indicators of the obtained products of the agglomeration process, with the fact that we included in the analysis experimentally determined values of the parameters of the input components.

4.1 Analysis of sample contents taken in measuring procedures

It is impossible to establish the aforementioned statement about individual amounts of applied substances in the sample taken for instrumental analysis in absolute terms, neither by analytical nor instrumental methods. For this reason, in this research, a model was applied that has undoubtedly acceptable accuracy in determining the participation of certain substances in the measuring sample (1 gram). Deviations from the absolutely correct proportions of this model, given in the following text, will not be relevant at all in order to significantly change the attitude about the influence on the relevant indicators in the research. The calculation model has the following conditions: that the samples were (and are) taken from individual experiments in which the mass of coal and sawdust was maintained, and the mass of pyrophyllite was changed, and ultimately these samples belong to a set of exactly defined briquettes. For this reason, an analysis of the content of the samples subjected to testing was carried out.

To begin with, the elemental composition of the obtained briquettes was calculated according to the recipes and the characteristics of the input components in the briquettes. All other briquette parameters in the total mass of added components were calculated in the same way. The calculation model is the same for all indicators, and in the following text the general principle of the model for calculating the values of these briquette parameters is given using the example of ash content:

$$P_B = \frac{(P_u \cdot m_u) + (P_D \cdot m_D) + (P_p \cdot m_p)}{m_u + m_D + m_p}; \%$$

where is:

- P_p - pyrophyllite ash, (%),
- m_p - mass of pyrophyllite in the mixture, (g),

- P_u - coal ash for briquettes, (%) ,
- P_D - wood sawdust ash, (%) ,
- m_u - total mass of coal in mixture A2, (g),
- m_D - total mass of sawdust in mixture A2, (g).

It is clear that the total fuel mass in the briquette consists of combustible components of coal and wood, because pyrophyllite does not contain combustible elements in its composition. From this fact, from the total mass introduced into the mixture, the share of combustible materials from sawdust coal in the briquette can be calculated from the following ratio:

$$S_{mb} = \frac{m_{Smu} + m_{Smd}}{m_{Smb}}; (\%) \text{ respectively, } S_{mb} = \frac{m_{Smu}}{m_{Smb}} + \frac{m_{Smd}}{m_{Smb}}; (\%)$$

So, in the briquette, the total quantity of combustible materials, in relative amounts, consists of combustible materials from coal and sawdust, the sum of which gives 100%, as given in the following form.

$$S'_{mu} + S'_{md} = 100\%$$

Therefore, taking the previous ratios, i.e. the relative shares of coal and sawdust in the combustible mass, and the established value of the combustible matter of briquettes, we can calculate the share of individual components in the combustible matter, from the following relationship:

$$S'_{mu} = \left(\frac{m_{Smu}}{m_{Smb}} \right) \cdot 100; \% \text{ and, } S'_{md} = \left(\frac{m_{Smd}}{m_{Smb}} \right) \cdot 100; \%$$

The absolute participation of individual components can then be obtained by multiplying this relative participation with the value of combustible materials in each of the briquette samples.

$$S_{mu} = S'_{mu} \cdot \left(\frac{S_{mb}}{100} \right); \text{ respectively, } S_{md} = S'_{md} \cdot \left(\frac{S_{mb}}{100} \right); (\%)$$

where is:

- m_{Smu} - mass of combustible materials from coal in the briquette, (g),
- m_{Smd} - mass of combustible materials from sawdust in briquettes, (g),
- m_{Smb} - mass of combustible materials in the briquette, (g),
- S_{mb} - proportion of combustible mass in the briquette, (%) ,
- S_{mu} - proportion of combustible mass of coal in briquette, (%) ,
- S_{md} - share of combustible wood mass in the briquette, (%) ,
- S'_{mu} - relative share of the combustible mass of coal in the briquette, (%) ,
- S'_{md} - relative share of combustible wood mass in the briquette, (%) .

With this condition, it is possible to determine the content of combustible mass from coal in each measured sample of briquettes according to the following formula:

$$SM_U = \left(\frac{S_{UKB}}{S_{UKU}} \right) \cdot SM_B, (\%)$$

where is:

- SM_U - combustible mass of coal in briquettes for sample, (%) ,
- SM_B - combustible mass of the *i*th briquette, (%) ,
- S_{UKB} - total sulfur of the *i*th briquette, (%) ,
- S_{UKU} - total sulfur from the coal of the *i*-th briquette, (%) .

By obtaining the value of the combustible mass of coal, it is easy to calculate the combustible mass of sawdust as the difference between this stated value and the total value for an individual sample. This model based on the example of calculating the content of combustible mass of coal and sawdust, and on that basis determining the participation of these two materials through the compilation of theoretically and experimentally obtained parameters is given in the example of A4 briquettes (ie A4-1, A4-2 and A4-3) in table 6.

Table 6. Analysis of briquette content according to combustible materials

Briquette		SM	Suku	Spu	Sgu	Coal	Sawdust
Analytical	A4	75,65	2,18	0,97	1,21	49,51	26,14
Experimentally	A4-3	75,05	2,69	1,14	1,55	61,00	14,05
Experimentally	A4-1	75,11	2,71	1,14	1,57	61,46	13,65
Experimentally	A4-2	75,38	2,77	1,15	1,62	62,82	12,56

Further analysis of the content of these samples taken from the briquettes according to this model that we present was done using ash, again approximating the results obtained from the analytical model, and the results of this analysis for sample A4 are given in table 7.

We obtained individual amounts of ash according to the following forms:

$$P_U = \left(\frac{P_{Bt}}{P_{Be}} \right) \cdot P_{Ut}, P_D = \left(\frac{P_{Bt}}{P_{Be}} \right) \cdot P_{Dt}, P_p = \left(\frac{P_{Bt}}{P_{Be}} \right) \cdot P_{pt}, (\%)$$

where is:

- P_U - coal ash in the i th briquette, (%)
- P_{Bt} - amount of ash in the analytical sample of the i -th pellet, (%)
- P_{Be} - amount of ash in the measuring sample of the i -th pellet, (%)
- P_{Ut} - amount of ash in the theoretical (analytical) sample of coal in the i -th pellet, (%)
- P_U - coal ash in the i -th briquette, (%)

Table 7. Analysis of briquette content according to ash in the measurement sample

Briquette	P	Coal	Sawdust	Pyrophyllite
A4	24,35	16,82	2,29	5,25
A4-3	24,95	17,23	2,34	5,38
A4-1	24,89	17,19	2,34	5,36
A4-2	24,62	17,01	2,31	5,30

The remaining samples from individual experiments were determined in the same way, and by adding the combustible mass and ash from coal, wood sawdust and pyrophyllite shale, we obtained the essential ratios of these substances, which were entered into the analysis, i.e. measurement in the instrument (e.g. for the heat value in the calorimeter 1 year). The analysis for sulfur was carried out in the same way and the results are given in table 8.

4.2 The effect of pyrophyllite on reducing the emission of sulfur gases in composite briquettes

It is clear that the introduction of materials that have a significantly lower amount of sulfur in their composition, such as wood sawdust and pyrophyllite, reduces the total amount of sulfur in the briquette. According to the tests of the basic components, and it was emphasized in the earlier text, that coal contains both forms of sulfur, and sawdust and pyrophyllite only one form of sulfur. According to this statement, the reduction of sulfur in the briquette results from the mass distribution of the briquette maker. At the same time, the mass distribution must be proportional to the total values entered by the briquette manufacturer and the values established by measuring in the instrument, for all types of sulfur (total, fuel and ash).

Another form or mechanism that can have an influence on the behavior of the mentioned form of sulfur is reflected in the content of pyrophyllite schist. The carbonates present in this shale change to Ca and Mg oxides when burning coal, which have a significant reactive power towards sulfur. In this way, the process of desulphurization with quicklime in coal-fired thermal power plants essentially takes place. During this, as a result of a chemical reaction, the mineral gypsum is formed, which turns into ash. The presence of a larger amount of sulfur in the ash than that obtained from the mass distribution speaks in favor of the fact of the conversion of fuel sulfur into sulfur in the ash. This statement is also observed in the TG analysis, where a loss of mass can be seen at temperatures of 850 °C, which would correspond to the loss of CO₂ from the present carbonates (Ca and Mg).

This fact, in turn, indicates part of the response of the mechanism of action of pyrophyllite in the briquette during combustion to the effect on the behavior of sulfur from coal. Released sulfur from coal and

calcium and magnesium oxide from carbonates are reactive, and as a result of their reaction, gypsum is formed. In this way, in addition to the sulfur in briquette ash that comes from non-combustible coal compounds, sulfur is also found that is released by burning. This mechanism can be seen in the research results through an increased amount of sulfur in the ash and a reduced amount of fuel sulfur, i.e. sulfur that is released into the atmosphere during combustion. The fact of the release of crystalline water from the pyrophyllite schist minerals and the possible reactions at the molecular level of these events should not be forgotten either. In addition to all of the above in terms of stating the possibility of reducing the amount of sulfur gases during the combustion of these and similar substances, the structure of the pyrophyllite mineral, which has the power to adsorb certain values into itself due to its fine, open porosity, should be emphasized.

So, the indicator of the influence on the atmosphere from the aspect of this kind of mixture in the briquettes is the mass reduction of the amount of sulfur in the fuel and the mutual relative relationship of the sulfur released after burning the briquettes. Based on the test results from the table, the total reduction of sulfur in relation to briquettes made of coal is calculated in the following table.

Table 8. Total sulfur reduction compared to coal briquettes

Briquette	Coal	Sawdust	Pyrophyllite	DTV, kJ/kg	Suk %	Sp %	Sg %	Reduction Suk, %
A1	100	0	0	17961	3,29	1,747	1,82	-
A2-3	73,06	18,8	8,14	18163	2,53	1,41	1,12	30,04
A2-2	73,94	17,95	8,12	17065	2,57	1,4	1,17	28,02
A2-1	73,31	18,66	8,03	18226	2,55	1,4	1,15	29,02
A4-3	75,05	19,57	5,38	17239	2,71	1,14	1,57	21,40
A4-2	75,11	19,53	5,36	17316	2,77	1,15	1,62	18,77
A4-1	75,38	19,32	5,3	16271	2,72	1,58	1,14	20,96
A3-3	73,6	24,62	1,78	18091	2,49	0,81	1,68	32,13
A3-1	73,36	24,86	1,78	18097	2,48	0,8	1,68	32,66
A3-2	74,25	23,99	1,76	18169	2,53	0,8	1,73	30,04
A5-3	68,27	31,73	0	18295	2,21	0,67	1,54	48,87
A5-2	70,21	29,79	0	18261	2,29	0,67	1,62	43,67
A5-1	72,25	27,75	0	16448	2,23	0,67	1,56	47,53

Let's look at the impact of individual briquette manufacturers on the total, fuel and sulfur in the ash. Figure 2 shows this dependence for coal, Figure 3 for sawdust and Figure 4 for pyrophyllite.

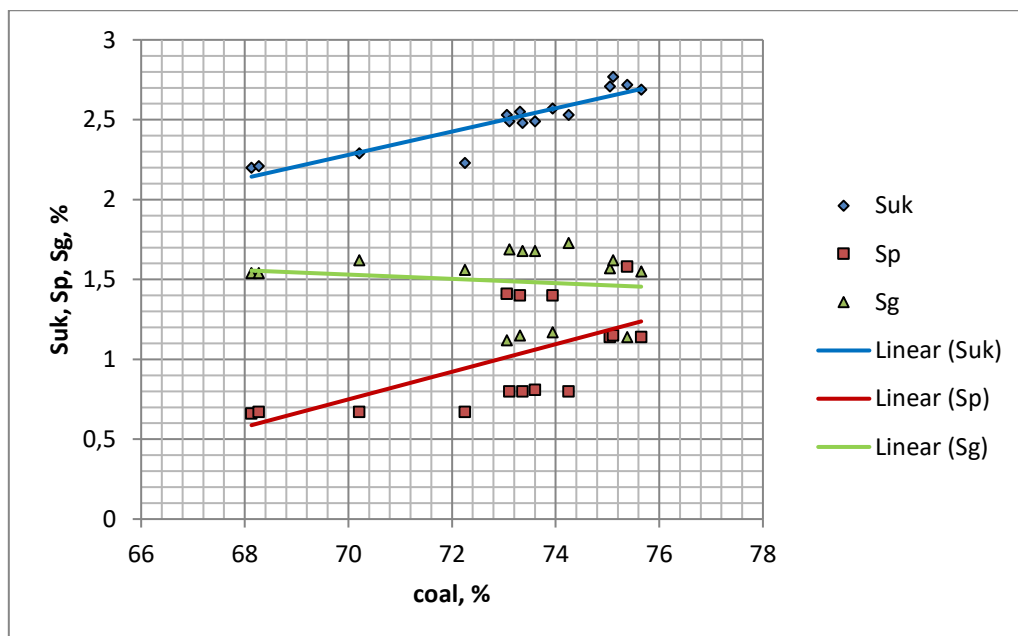

Figure 2. Influence of coal from briquettes on sulfur

According to this figure, coal affects the total sulfur in such a way that with its increased participation in the mixed briquette, the total sulfur and sulfur in the ash increase, while the fuel sulfur decreases very little.

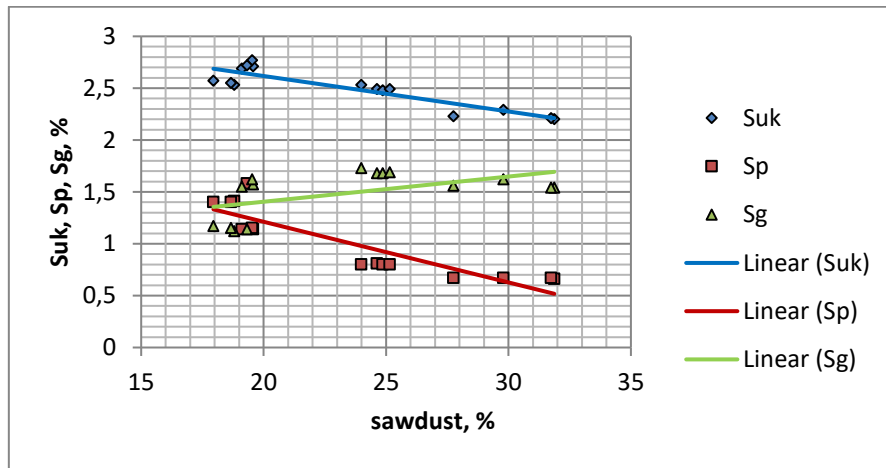

Figure 3. Effect of briquette sawdust on sulfur

From this relationship, it is evident that with the growth of sawdust in the briquette, the total amount of sulfur decreases, as well as the amount of sulfur in the ash, while the amount of fuel sulfur increases.

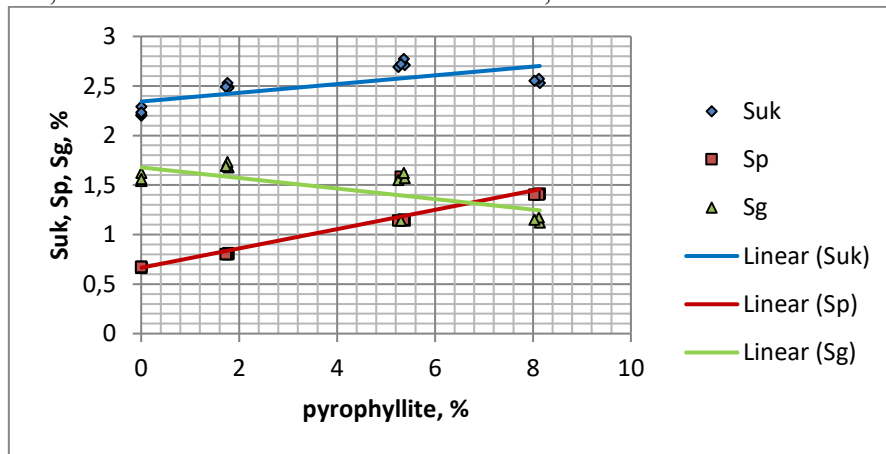

Figure 4. Effect of pyrophyllite from briquettes on sulfur

Increasing the content of pyrophyllite shale in the briquette leads to a slight increase in total sulfur, but a significant trend in the change of sulfur in ash, which is rapidly increasing, and a significant decrease in fuel sulfur. The reduction of the total and individual amounts of fuel and sulfur in the ash is also related to the "dilution" of the same in the coal through the addition of wood sawdust and pyrophyllite, which contain significantly less sulfur. This mass dilution of sulfur is calculated and given in table 9, with the fact that the results of the measured values of the same indicators obtained from the experimental samples are given in comparison.

Table 9.

Briquette	Coal in briquettes average %	Pyrophyllite schist	Due to dilution			Experimentally		
			Sukt	Sp	Sg	Suk	Sp	Sg
A1	100,00	0,00	3,29	1,470	1,820	3,290	1,470	1,820
A2	70,24	0,00	2,31	1,033	1,278	2,243	0,670	1,573
A3	73,74	1,77	2,43	1,084	1,342	2,513	1,003	1,510
A4	75,18	5,35	2,47	1,105	1,368	2,563	1,063	1,500
A5	73,44	8,10	2,42	1,080	1,337	2,550	1,403	1,147

The ratio of the reduction of all forms of sulfur in briquettes to mass dilution with the addition of wood sawdust and pyrophyllite are given in the diagram of figure 5 for total, figure 6 for fuels and figure 7 for sulfur in ash.

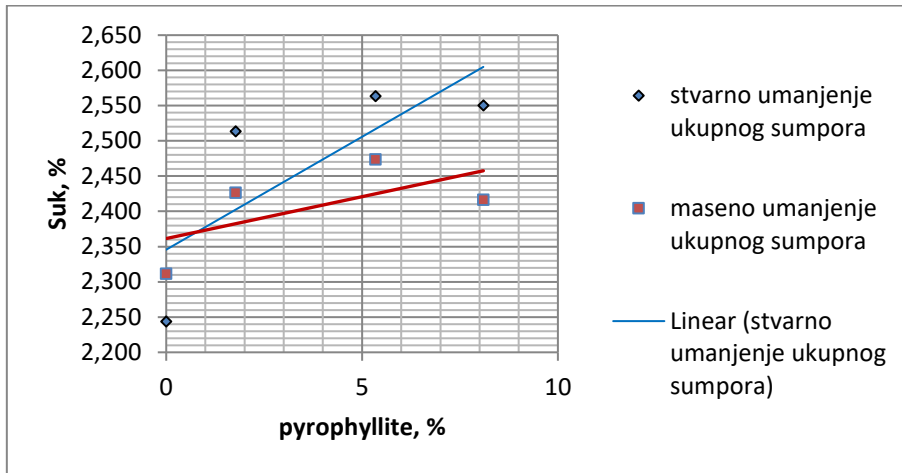

Figure 5. Relationship between mass and experimentally determined total sulfur according to the amount of pyrophyllite shale in the briquette

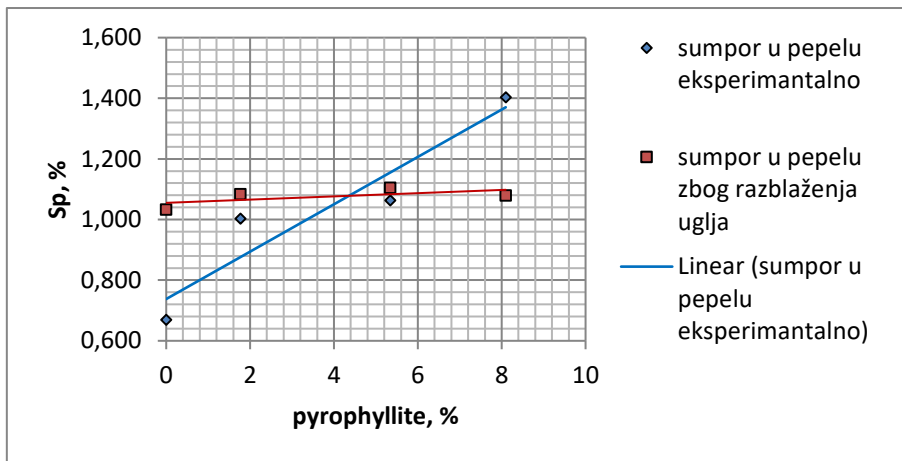

Figure 6. Relationship between mass and experimentally determined total sulfur according to the amount of pyrophyllite shale in the briquette

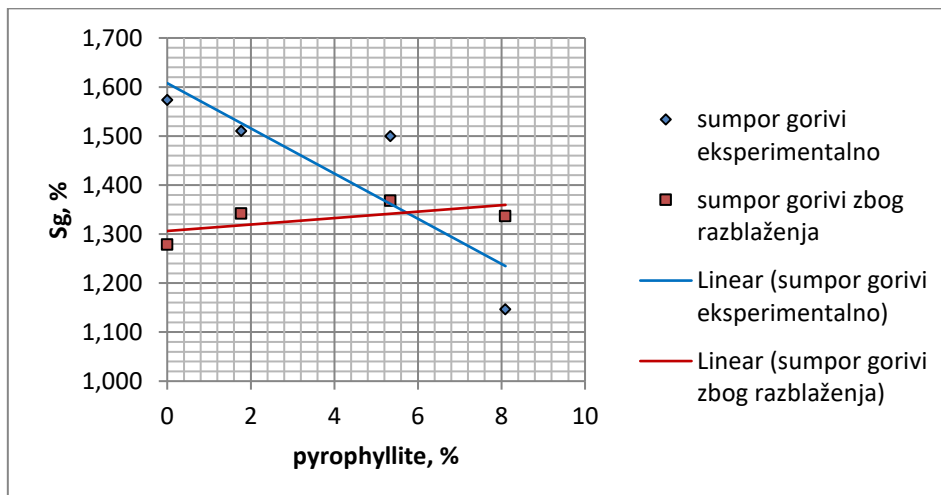

Figure 7. Relationship between mass and experimentally determined total sulfur according to the amount of pyrophyllite shale in the briquette

CONCLUSION

The hypothesis itself is based on the environmental impact of burning coal, primarily on the atmosphere. For this reason, the majority of research is devoted to the emission of gases released during this process. The focus is on sulfur as the primary environmental problem in coal combustion and it is investigated in detail. The recipe of the experimental briquette samples was set in such a way that the fuel materials coal and wood, pine sawdust, always reflected the same meaty part, and pyrophyllite was added to different briquettes with variable mass. A total of five different combinations of this mixture were made in individual quantities of approx. 2.00 kg. For the initial experimental sample, a briquette with 100% coal content was made, and the other four constantly had 1400 grams of coal, 600 grams of wood sawdust and 40, 120 and 200 grams of pyrophyllite shale. Briquettes are made in laboratory conditions. So the analysis required two interdependent steps. In the first step, the analysis of the obtained indicators had a two-fold task: analytical calculation of relevant research indicators based on the given recipe and tested indicators of input components, and analytical calculation of the content of the samples subjected to measurements.

The key indicator of the research and the answer to the set hypothesis of the work is reflected through the analysis of sulfur gases in the process of burning experimental briquettes. In this case too, the present inhomogeneities can be noticed, emphasized as in the previously described conclusion. These inhomogeneities can be approximated by observing the trend of set dependencies in analytical and instrumental measurement of experimental briquettes. Namely, it is logical that the analytical finding itself shows a reduction of all forms of sulfur depending on a kind of "dilution" of coal matter (the main sulfur carrier) with sawdust and pyrophyllite shale. From this aspect, the obtained results show certain deviations, but the trend of these indicators observed for analytically obtained and results obtained in instrumental measurement methods for total sulfur is similar. However, the distribution of total sulfur in the fuel and in the ash in the context of observing the results obtained due to the mass reduction of coal in the briquette for the analytical model and the experimental results is significantly different.

On the diagram of picture number 6, a slight growth trend is visible with a change in the content of pyrophyllite schist in the briquette with analytical and sudden growth of sulfur in the ash. On the contrary, and it is visible in the diagram of picture number 7, that the trend is similar in the analytical model, and completely opposite in the experimental model.

These diagrams are the indicators that can be used to confirm the working hypothesis, the addition of pyrophyllite shale to the coal mass reduces the impact of sulfur gases obtained from the combustion of this mixture on the atmosphere.

LITERATURE

1. A. M. Goden, (1950.): Principi pripreme mineralnih sirovina za dalju preradu, Beograd
2. Alić N., (2020): "Istraživanje mogućnosti koncentracije pirofilita, iz ljubičastog varijeteta škripljca, ležišta Parsovići", Studija, RGGF Tuzla
3. Alić N., (2020): Usitnjavanje u pripremi mineralnih sirovina, Univerzitetski udžbenik RGGF Tuzla
4. Alić N., (2022): Klasiranje mineralnih sirovina, Univerzitetski udžbenik RGGF Tuzla
5. Alić N., (2020): Mogućnost alternativne primjene ugljeva krekanskog bazena, Glasnik RGGF Tuzla
6. Razić R., (2024): Modeliranje kompozitnog briketa na bazi uglja u cilju smanjenja emisije produkata sagorijevanja u atmosferu, Doktorski rad, RGGF Tuzla
7. Petrović M. (2008.): Priprema mineralnih sirovina - Osnovi aglomeriranja, Printcom, Tuzla
8. Toročešnikov N. S. i dr. (1981.): Tehnika zaštite okružujuće sredine. Moskva,
9. Tomanec R., A. (2000): Metode ispitivanja mineralnih sirovina u pripremi mineralnih sirovina, Rudarsko Geološki fakultet u Beogradu,
10. Prospektna, operativna, projektna i tehnička dokumentacija AD Harbi d.o.o Sarajevo, 1963 do danas

RECYCLING OF MATERIALS FROM THE EXCAVATION OF THE "POČITELJ" TUNNEL AND INCORPORATION OF THE OBTAINED PRODUCTS IN THE TUNNEL THROUGH CONCRETE AND BLINDING LAYER

Ekrem Bektašević¹, Hrvoje Antičević², Kemal Gutić³, Denijel Sikira⁴

ABSTRACT

In civil engineering or road construction, especially when constructing tunnels, large quantities of excavated material are created. In many cases, this material, if properly treated and processed, can be recycled and reused on site. If this material is not treated as planned from the beginning of the project, but is taken to the landfill and mixed with bad material or construction waste, then when the need for it arises, it is difficult to separate it and return it to the construction process. In the simplest case, the material can be used as an embankment to the extent that it meets the requirements regarding the quality of the embankment material. Better quality material can often be recycled to make fractions for various types of concrete, buffer aggregates or decorative stone walls (architectural stone). In the current example of the "Počitelj" tunnel, through tests of fractions, definition of recipes, recycled material from tunnel excavation was successfully used as aggregate for shotcrete, concrete for inner lining and construction, buffer, bedding for laying pipes and making front slopes from crushed stone. This reduced the purchase and transport of aggregates from local quarries to the minimum possible, thus saving resources, with financial benefit. In summary, through this example, it can be noted that the reuse of tunnel excavation will play an important role for future tunnel projects due to environmental and economic reasons.

Keywords: tunnel, excavation, limestone, concrete, blinding layer, recycling

INTRODUCTION

The strategy of extensive material recycling has already been successfully implemented in the construction of some of the longest tunnels in the world: the Swiss Lötschberg and Gotthard Base Tunnels [1]. There, the construction site's own production was carried out with recycled aggregate, which was mostly produced on the construction site [2]. In other research projects, it could be shown that, with the fulfillment of certain conditions, excavation was used as an aggregate resource for road construction. [3].

A scientific approach to the use of excavated materials extends from the planning and decision-making process of handling excavated materials to technological implementation, focusing on technical development in relation to material analysis and realization of raw materials [4]. Therefore, large international research projects have been carried out in the framework of sustainable production of raw materials and recycling. Not least, structural engineering considerations must be taken into account in tunnel design when using recycled aggregate for construction concrete to meet the design service life of the tunnel structure. [5].

¹Ph.D. graduate mining engineer, "PPG" d.o.o. Sarajevo, bektasevic.ekrem@gmail.com;

² Ph.D. graduate mining engineer, Krešo Geo d.o.o. Zagreb, anticevic.zagreb@gmail.com

³ Full professor, Faculty of mining, geology and civil engineering University of Tuzla, kemal.gutic@untz.ba

⁴"FM INŽENJERING" d.o.o. Sarajevo, denijal.sikira@gmail.com

Especially in terms of saving resources and protecting the environment - the goal must be the maximum share of material recycling and its incorporation, and not its disposal as "tailings" in a landfill. As a result, a high level of material recycling was achieved from the excavation of the "Počitelj" tunnel, which was constructed on the Zenica-Sarajevo-Mostar highway, the Počitelj-Bijača section, the Počitelj-Zvirovići subdivision. Most of the excavated rock material was used there during continuous tunnel excavation with particular importance in terms of quality management due to its use for high quality concrete products such as linings, structural concrete and blinding layer embankment.

Geological characteristics of the terrain in the "Počitelj" tunnel construction zone

Generally speaking, the area belongs to the mountainous terrain, with altitudes ranging from 134.0 to 261.0 m. The maximum elevation of the terrain above the level of the tunnel is 261 m.a.s.l. that is, the maximum height of the upper layer is about 110m.

On the basis of the engineering-geological mapping of the terrain and the core from the exploratory boreholes, in the engineering-geological sense, the following categories were distinguished:

- Eluvial-deluvial formations,
- Degraded geological substrate and
- Geological substrate.

Eluvial-deluvial formations are separated at the surface part of the field. It was created as a result of erosion-denudation processes on the surrounding slopes. According to the results of exploratory drilling, a lithological member of humus clay, red-brown in color, was isolated. Humus clays are represented in the surface parts of the terrain, positioned directly over the weathering crust of the geological substrate. The thickness of the deluvial cover is variable and ranges from 0.50 to 1.20 m.

Degraded geological substrate is represented as disintegrated and decomposed limestone. The thickness of the swollen formations of the degraded geological substrate ranges from up to 3.0 m. From the engineering-geological aspect, these zones build conditionally stable to stable terrains.

Geological substrate represents limestone. Limestone has a massive texture and less often thick-layered. In some places, these rocks have cracked more strongly with the presence of a system of cracks due to the karstification process. Clasts have a layered, bank-like to partially massive texture and a crystalline to cryprocrySTALLINE structure. These are rock masses with fissure-cavernous porosity. The position of the stratification in relation to the disposition of the tunnel route is generally favorable, if one takes into account the construction of the tunnel from the direction of the exit portal. They build stable terrains with favorable mechanical properties.

Recycling of excavated material during the construction of the „Počitelj tunnel“

The length of the right tunnel tube of the "Počitelj" tunnel, including the portal structure, was 1163.0m', while the length of the left tunnel tube was 1192.0m'. The tunnel tubes are connected with three pedestrian crossings and one passage for emergency vehicles. The excavation area on average was approx. 73 m²/m' of the tunnel. If we subtract from the total length the portal construction, and approx. 5m' of degraded geological substrate including eluvial-deluvial formations, we get the total length of both tubes of 2300m', the material of which is recycled. The total amount of material that had to be recycled from excavation can be calculated using the following formula:

$$U = L \cdot P \cdot \gamma$$

Where:

- U - total amount of recycled material from excavation (ton.),
- L - the total length of both tubes whose material is recycled, in our case is 2,300 (m),
- P - average excavation area, in our case is 73 (m²),
- γ - volumetric mass with pores and cavities, in our case it is 2,67 (t/m³).

So we can calculate the total amount of material that had to be recycled from the excavation of the Počitelj tunnel:

$$U = L \cdot P \cdot \gamma = 2300 \cdot 73 \cdot 2,67 = 448.293 (t)$$

When defining the area for dumping excavated material from the tunnel and the area for recycling, care was taken to ensure that it was in the immediate vicinity of the tunnel location itself, in order to reduce transport costs to the lowest possible level and achieve significant benefits. The spatial location of the

deposition of excavated material from the Počitelj tunnel is shown in Figure 1.



Figure 1. Location of the excavated material dump and its recycling in relation to the entrance to the tunnel [6]

At the very beginning of the excavation of the tunnel, and before the start of recycling the excavated material, a test of the physical and mechanical characteristics of the rock material from the excavation was carried out. Table 1 shows the physical and mechanical characteristics of the rock from the excavation of the Počitelj tunnel.

Table 1. Physical and mechanical properties of the rock from Pošitelj tunnel excavation [7]

<i>Tested properties</i>	<i>Test method</i>	<i>Test results</i>	<i>Quality conditions</i>	
			<i>Concrete JUS B.B2.009</i>	<i>Asphalt concrete JUS U.E4.014</i>
Compressive strength in dry state (MPa)	JUS B.B8.012	max. 207,0 min. 154,0 avg. 185,0	min.80 MPa min.160 MPa*	Highway; very difficult and difficult min.160 MPa**
Water-saturated compressive strength (MPa)		max. 190,0 min. 150,0 avg. 165,0		average; min.140 MPa** light and very light; min.120 MPa**
Loss of compressive strength (%)	JUS B.B2.009	10,37	max 20 %	-
Frost resistance (Na ₂ SO ₄) (%)	JUS B.B8.002	0,06	max.5 %	max.5 %
Water absorption (%)	JUS B.B8.010	0,30	max.1 %	Highway; very difficult and difficult max. 0,75% average; max. 0,75% light and very light; max. 1%
Volumetric mass with pores and voids (g/cm ³)	JUS B.B8.032	2,67	2-3 g/cm ³	-
Volumetric mass without pores and voids (g/cm ³)		2,70	2-3 g/cm ³	-
Volumetric mass coefficient		0,987	-	-
Porosity (%)		1,303	-	-

Based on the analyzes of the excavated rock, the possibility of using recycled products from the mentioned rock in all types of concrete as well as road construction for making the blinding layer has been confirmed. The arrangement of the selected area on which the rock material from the excavation will be recycled was carried out, and the necessary equipment for the recycling of rock material from the tunnel excavation was mobilized and installed, Figure 2.

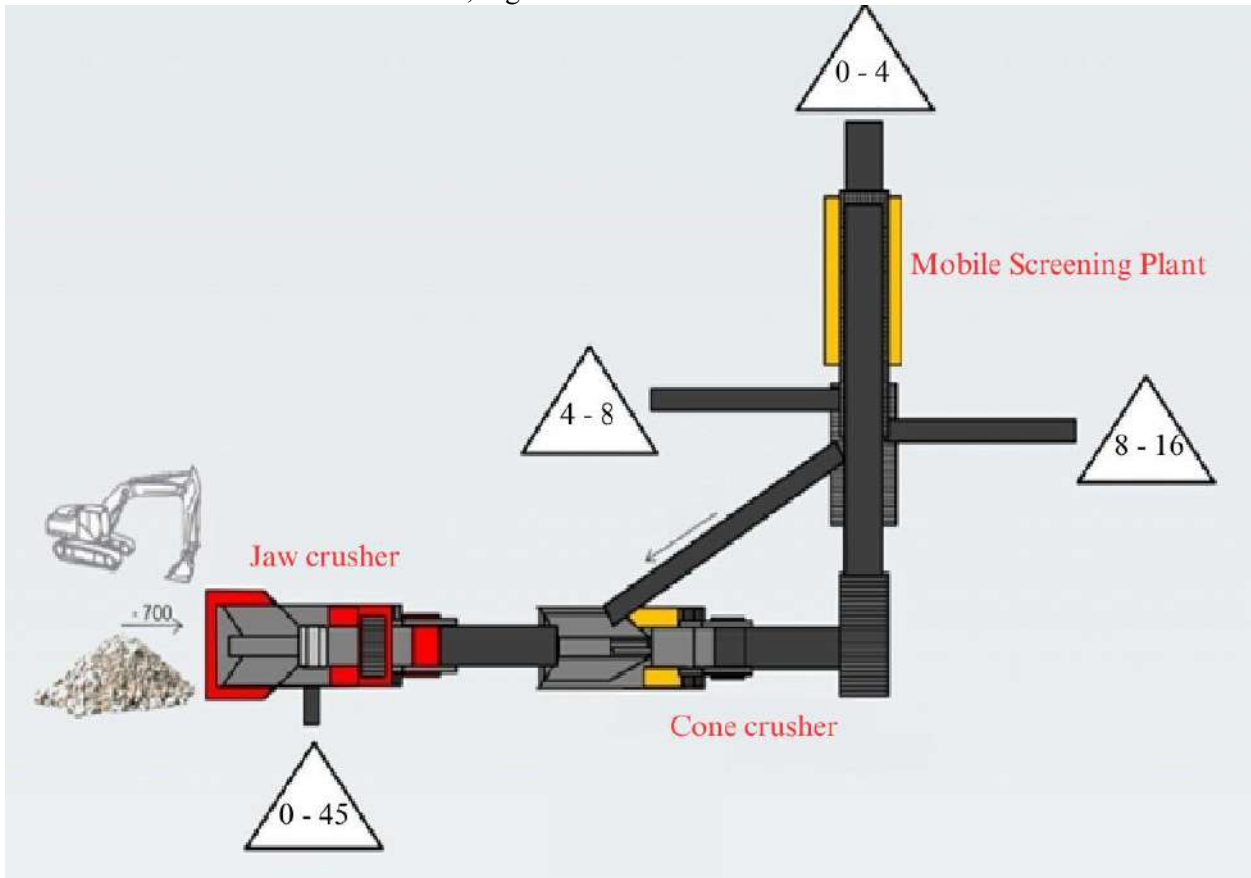

Figure 2. Schematic view of the installed equipment for recycling rock material from tunnel excavation

Demined material from the excavation of the tunnel was transported by trucks to the plateau not far from the entrance to the tunnel (Figure 1), where a material recycling plant was installed as shown in Figure 2. The material delivered by an excavator or a loader was dosed to a jaw crusher where material with a coarseness of 0 - 45mm (which was used as a blinding layer) while the over-sieved product of the vibro grid with a granulation of 150 - 45mm was sent to the cone crusher by belt conveyor. In the cone crusher, stone material was additionally crushed to a granulation of 0-20 mm. After the cone crusher, the material was transported by a rubber conveyor to a mobile seeder, where the material delivered from the cone crusher was classified into final fractions: 0-4, 4-8 and 8-16mm. The fraction that is larger than 16 mm is returned by belt conveyor to the cone crusher for additional crushing. The entire amount of excavated material during the excavation of the Počitelj tunnel was recycled. The smaller amount that was excavated at the entrance and exit portal and belongs to eluvial-deluvial formations and degraded substrate was used on the access routes with refinement with limestone granulate.

Incorporation of the products obtained by recycling in the tunnel and access route

Before the actual use of the recycling aggregate, it was necessary to prove its usability, as a result of which aggregate controls were carried out in accordance with the valid technical regulations and requirements of the EN 206-1 standard, as well as the provisions of the cement concrete specification [8]. The results of aggregate tests are shown in the following tables (Table 2).

Table 2. Physical and geometric properties of aggregates [7]

Tested characteristics (According to the guidelines for design, construction, maintenance and supervision on roads Book II: Construction, Part 2: Special technical conditions i Regulations for concrete)	Test method	Test results		
		Nominal fraction (mm)		
		0/4	4/8	8/16
Proportion of grain size up to 0,063 mm (%)	BAS EN 933-1:2012	11,5	0,5	1,0
Sand equivalent, SE (%)	*BAS EN 933-8+A1:2016	66	-	-
Bulk density, ρ_b (Mg/m ³)	*BAS EN 1097-3:2007	1,546	1,300	1,374
Resistance to crushing, LA (%)	*BAS EN 1097-2:2011	-	-	24
Grain density, ρ_a (Mg/m ³)	*BAS EN 1097-6:2014	2,726	2,721	2,742
Water absorption, WA ₂₄ (%)		0,31	0,53	0,46
Frost resistance, MS (%)	*BAS EN 1367-2:2011	-	-	1,0
Frost resistance, N _{a2} SO ₄ (%)	*JUS B.B8.044	0,47**	0,48	0,50
The grain shape of the coarse aggregate, SI (%)	*BAS EN 933-4:2011	-	13	13

(**) – examined on the fraction 2/4mm

Table 3. Granulometric analysis of small aggregates (BAS EN 933-1:2012) [7]

Faction label d/D (mm)	Passing through the sieve (%)										
	0,063	0,09	0,125	0,25	0,5	0,71	1	2	D	1,4D	2D
0/4	11,5	13,6	16	26	42	51	66	89	100	100	100

Table 4. Granulometric analysis of coarse aggregate (BAS EN 933-1:2012) [7]

Faction label d/D (mm)	Passing through the sieve (%)											
	0,063	0,09	0,125	0,25	0,5	1	2	d/2	d	D	1,4D	2D
4/8	0,5	0,5	1	1	1	1	1	1	11	97	100	100
8/16	1,0	1,0	1	1	1	1	1	1	10	98	100	100

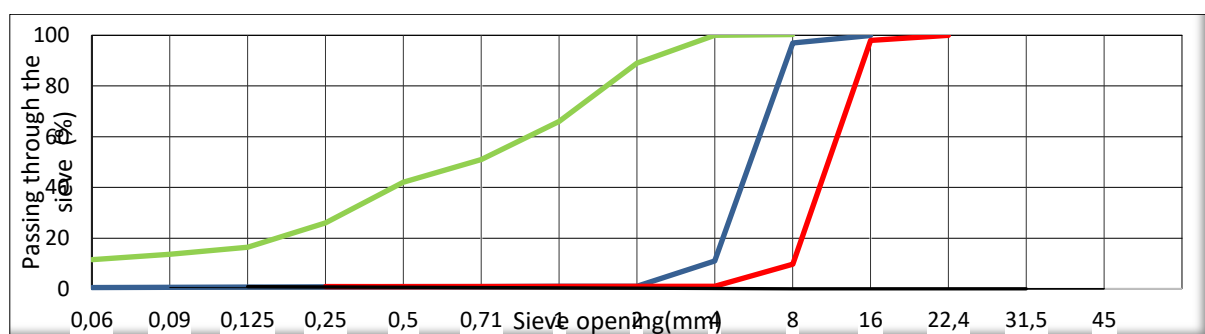

Figure 3. Graphic representation of granulometric composition - (BAS EN 933-1:2012) [7]

Mineral-petrographic and chemical analysis of the fractionated rock aggregate from the excavation of the "Počitelj" tunnel was performed by the Faculty of Mining, Geology and Civil Engineering, University of Tuzla according to standard norms. Table 5 shows the mineral and petrographic composition of the aggregate [9].

Table 5. Mineral-petrographic composition of aggregates

Genetic type	The name of a rock or mineral	Large aggregate		Small aggregate
		Content of mineral-petrographic species in % mass		
		8 - 16	4 - 8	0 - 4
Sedimentary rocks	Gray to brown crystalline limestones. Some of the fragments are coated with limonite scum. The fracture is irregular, with irregular to shell-like fracture surfaces. Individual fragments are interspersed with cracks (filled with secondary, transparent calcite) of irregular orientation and different diameters. The reaction to dilute HCl acid is violent and immediate. The insoluble residue is negligible.	95	95	96
Minerals	Calcite/secondary, translucent to white	3	3	1
	Limonit (skrama)	2	2	4
TOTAL:		100	100	100

Table 6 gives an overview of the ingredients that could be harmful to the concrete mix to the extent that they would be contained in the fractions.

Table 6. Overview of the presence of ingredients that can be harmful in the concrete mix [9]

The name of the identified potentially harmful components in the aggregate	Large aggregate		Small aggregate
	Content of mineral-petrographic species in % mass		
	8 - 16	4 - 8	0 - 4
<i>INGREDIENTS THAT CAN BE HARMFUL FOR PHYSICAL - MECHANICAL PROPERTIES</i>			
Changed grains (worn and weak grains)	0	0	0
Clay sandstones	0	0	0
Marls and marly carbonates	0	0	0
Clay rocks, mica rocks, phyllites, etc.	0	0	0
Grains with scraps of limonite, clay and opal	2	2	1
Gypsum (gypsum) and anhydrite	0	0	0
Clay and clays	0	0	0
Serpentine, mica and siltstone	0	0	0
Coal	0	0	0
TOTAL:	2	2	1
<i>INGREDIENTS THAT MAY BE REACTIVE</i>			
Opal (Amorphous SiO ₂)	0	0	0
Tridymite, cristobalite, zeolite	0	0	0
Horns with opal	0	0	0
Acid silicate glasses	0	0	0
Dolomitized limestones with clay minerals	0	0	0
Hydromics (illite and sericite)	0	0	0
TOTAL:	0	0	0
<i>SASTOJCI KOJI MOGU PROUZROKOVATI KOROZIJU ARMATURE U BETONU</i>			
Halite	0	0	0
Silvina	0	0	0
Pyrite oxidized	0	0	0
Marcasite	0	0	0
Pirhotin	0	0	0
Anhydrite	0	0	0
Tuff	0	0	0
TOTAL:	0	0	0

Table 7 shows the results of chemical tests of the fractions obtained by recycling stone material from the excavation of the "Počitelj" tunnel.

Table 7. Results of chemical tests of fractions [9]

Parameters	Units	Methodology	Results	MDK
Fraction soluble in water				
Chlorides	%	JUS.B.B8.042	0,002	0,1 % AB 0,02% PB
Fraction soluble in acid				
Sulfates as SO ₃	%	JUS.B.B8.042	0,005	-
Total sulfur	%	JUS.B.B8.042	0,15	-
Content of total carbonates	%	JUS.U.B1.026	94,86	-

On the basis of mineral-petrographic tests, it can be concluded that the analyzed fractionated aggregates mostly belong to sedimentary, carbonate rocks: limestones, crystalline structures and homogeneous textures. The aggregate contains little (negligible) limonite scum. Ingredients that can cause the destruction of concrete, as well as ingredients that can be reactive under certain conditions, have not been identified. Ingredients that can be harmful to physical-mechanical properties are within very low limits. The results of chemical tests indicate low values of chloride and total sulfur regarding the use of fractions for the production of all types of concrete. A high percentage of total carbonate content (94.86%) indicates the purity of the aggregate.

Concrete trial production and installation

Before starting the mass production of concrete, it is necessary to check and prove the recipes of the cement concrete mixture in production on the appropriate production base [5]. Not far from the plateau where the excavated material was recycled during the excavation of the tunnel, the contractor installed a concrete plant for the production of all cement concrete from the fractions obtained from the recycling, figure 4.



Figure 4. Layout of the installed concrete plant for concrete production [6]

Before the trial production and installation of any class of cement concrete, the composition of the specified concrete recipe was adopted at the contractor's concrete plant. In addition to the adoption of the composition of the concrete recipes, it was necessary to establish the correctness of the landfill and

production plant for fresh cement concrete mixtures, the correctness of the chosen method of transportation and installation equipment, and to take samples of the mixture at the place of installation to test the characteristics of fresh and hardened cement concrete. In the continuation of the work, a presentation of one of the adopted recipes, which refers to shotcrete C25/30, XC2, Dmax8, C10.2, S4, and the results of the control and testing on the said shotcrete [10] is given.

Table 8. Adopted shotcrete recipe C25/30, XC2, Dmax8, C10.2, S4 [10]

Type of concrete	<i>MLAZNI BETON C25/30</i>			
Concrete strength class	C25/30			
v/c factor	0,47			
Concrete composition for 1000 liters of fresh concrete				
		kg/dm ³	dm ³	kg
Cement:	CEM II/B-W 42,5N, TC Kakanj	3,00	145,20	450
Water:	Local water supply	1,00	211,00	211
Additive:	Dynamon LZP 4710, MAPEI	1,05	2,83	3
Aggregate:		2712	610,60	1656
Residual air pores:		0	30,00	0
Total			1000	2320
Distribution of aggregates by fractions (kg)				
1	0/4 mm	crushed	70 %	1158
2	4/8 mm	crushed	30 %	498

Table 9. Participation of individual fractions in the shotcrete mixture [10]

Fraction	Part (%)	(%) passes through the opening sieve # (mm)										
		0,063	0,09	0,125	0,25	0,5	1	2	4	8	16	31,5
0/4 mm	70	7,2	8,7	10,6	14,6	21,7	34,1	50,0	69,6	70,0	70,0	70,0
4/8 mm	30	0,2	0,2	0,3	0,3	0,3	0,3	0,3	1,8	27,4	30,0	30,0
TOTAL:	100	7,4	8,9	10,9	14,9	22,0	34,4	50,3	71,4	97,4	100,0	100,0

Figure 5 shows the granulometric curve of the shotcrete mix with Dmax 8mm.

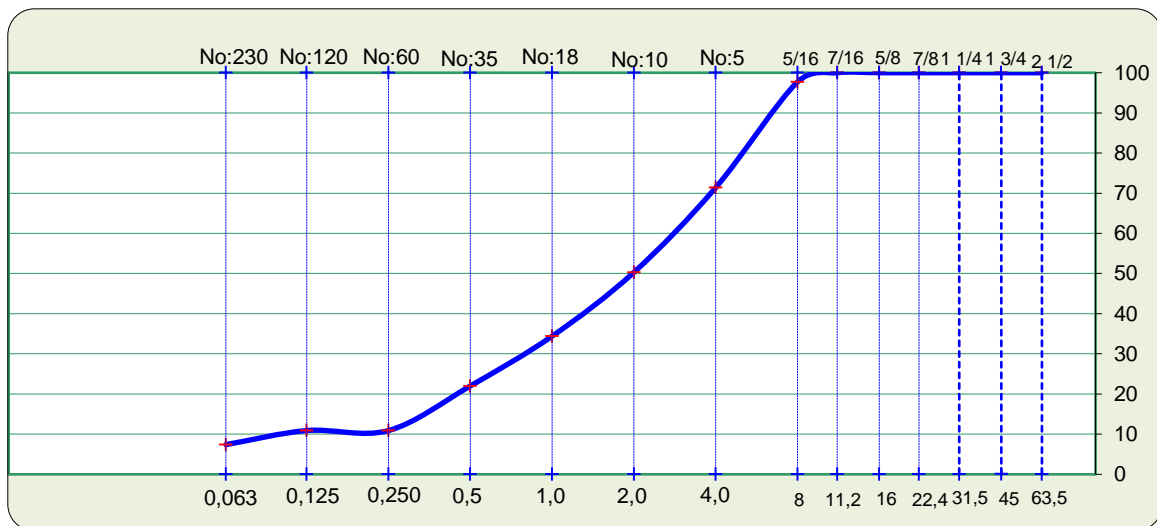

Figure 5. The granulometric curve of the shotcrete mix with Dmax 8mm [10]

Table 10 shows the results of testing the early compressive strength of shotcrete after 60 minutes, while Table 11 shows the results of the strength development of shotcrete at 24 hours.

Tabela 10. Rana pritisna čvrstoća mlaznog betona prema BAS EN 14488-2:2008 [10]

No/ minute	Penetrometer testing (MEYCO)										average value	compressive strength (MPa)
	1	2	3	4	5	6	7	8	9	10		
6	12	10	14	11	12	12	16	9	10	11	11,7	0,18
15	24	26	26	30	28	29	24	30	30	28	27,5	0,42
30	38	38	42	40	42	44	46	36	42	42	41,0	0,62
60	61	57	60	62	55	57	60	62	62	60	59,6	0,91

Table 11. Test of fresh shotcrete by screwing [10]

Time [hours]	screw length [mm]	Screw test											average value
		1	2	3	4	5	6	7	8	9	10		
24	80	38	48	48	46	50	42	39	45	41	47	44,4	
penetration (mm)		42	32	32	34	30	38	41	35	39	33	35,6	
pulling force(N)		4600	3600	3500	4700	2800	4000	3700	4000	2900	3100	3690,0	
calc. force (N)		4370	3420	3325	4465	2660	3800	3513	3800	2755	2945	3505,3	
compressive strength (MPa)		13,9	14,3	13,9	17,4	11,9	13,4	11,5	14,5	9,5	12,0	13,2	

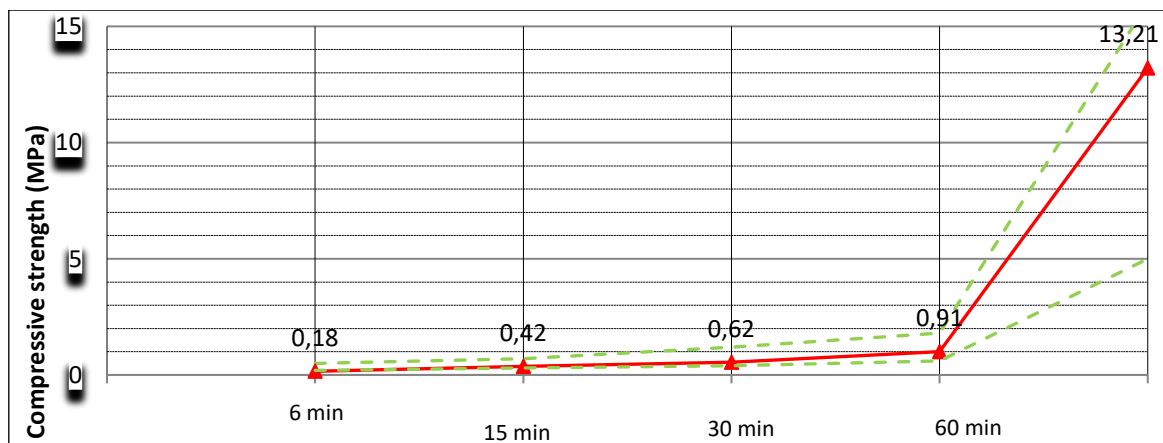

Figure 6. Diagram of increase in strength of shotcrete [10]

Testing of the compressive strength of shotcrete according to the standard BAS EN 12504-1:2020/Cor1:2022, age of samples of 7 days is shown in table 12.

Table 12. Testing the compressive strength of shotcrete, 7 days old [10]

mark	age (days)	diameter (mm)	height (mm)	weight (g)	volumetric mass (kg/m ³)	breaking force (kN)	compressive strength (MPa)
25-TPC-20	7	99,8	100,2	1821	2324	308,8	39,5
25-TPC-20	7	99,8	100,6	1810	2301	263,2	33,7
25-TPC-20	7	99,8	100,8	1807	2293	245,4	31,4
Medium value:							34,8

Testing of the compressive strength of shotcrete according to the standard BAS EN 12504-1:2020/Cor1:2022, age of samples of 28 days is shown in table 13.

Tabela 13. Testing the compressive strength of shotcrete, 28 days old [10]

<i>mark</i>	<i>age (days)</i>	<i>diameter (mm)</i>	<i>height (mm)</i>	<i>weight (g)</i>	<i>volumetric mass (kg/m³)</i>	<i>breaking force (kN)</i>	<i>compressive strength (MPa)</i>
25-TPC-20	28	99,8	100,4	1804	2298	356,0	45,5
25-TPC-20	28	99,8	100,0	1811	2316	407,7	52,1
25-TPC-20	28	99,8	100,2	1819	2322	374,5	47,9
<i>Medium value:</i>							48,5

Based on the analysis and test results of the designed shotcrete composition (C25/30, XC2, Dmax8, C10.2, S4, composition marks C25/30 MB/III), to conclude that the shotcrete meets all the criteria defined by the relevant technical conditions and standards.

CONCLUSION

Recycling of materials during tunnel excavation is becoming more and more important in the world, including in Bosnia and Herzegovina. This is not only due to the large quantities of excavated rock mass that must otherwise be disposed of in the area, but also due to ecological and economic reasons during the construction of the mentioned tunnels. In times of sustainability, resource efficiency and emissions minimization, it is a logical decision to recycle and reuse the excavated tunnel material as much as possible depending on the characteristics of the rock material.

In this work, it was shown that for the successful implementation of recycling, previous research on the quality of the rock mass in the tunnel excavation zone, as well as adequate technical performance of the concrete processing and mixing plant, is necessary. This is followed by the trial production of aggregates from the excavated raw material with the collection of data on the achieved characteristics of the aggregates and the processing process. The goal here is to test different types of crushers and mills, to find optimal machines for crushing and screening in order to achieve optimal geometric properties of the produced aggregates. Implementation of an efficient and adequate treatment facility plays a key role in the success of recycling implementation. In the case of the current example, a two-stage crushing system using a jaw and cone crusher, as well as sieving on a vibrating sieving with three sieving levels, was applied. A sprinkler system was installed at the complete processing and sieving plant with the aim of reducing the emission of dust emissions into the atmosphere. After optimizing the aggregate quality, concrete testing is required to find concrete mix performances for different types of concrete and applications that ensure high stability and durability of concrete structures.

In the current example of the "Počitelj" tunnel, through tests of fractions, definition of recipes, recycled aggregate was successfully used as aggregate for shotcrete, concrete for inner lining and concrete for structures. This reduced the purchase and transport of aggregates from local quarries to the minimum possible, thus saving resources, with financial benefit. In summary, through this example, it can be noted that the reuse of tunnel excavation will play an important role for future tunnel projects due to environmental and economic reasons.

LITERATURE

1. Lieb, R.H. Materials management at the Gotthard Base Tunnel—Experience from 15 years of construction. *Geomech. Tunnelbau* 2009, 2, 619–626. [CrossRef]
2. Thalmann, C. Ergänzende Prüfungen zu den bestehenden Beton-Normen für gebrochene Zuschlagstoffe—Erfahrungen beim AlpTransit Gotthard. *Z. Schweiz. Ing. Archit.* 1994, 24, 532–536. (In German)
3. Mlinar, C.; Sempelmann, F.; Koch, G.; Steiner, M.; Kubin, F. Tunnel spoil as a source of raw materials for an autobahn—Sustainable reuse of resources through the example of the S 10/Tunnelausbruch als Rohstoffquelle für eine Autobahn—Nachhaltige Ressourcenverwertung am Beispiel der S 10. *Geomech. Tunnelbau* 2014, 7, 428–436. [CrossRef]

-
4. Erben, H.; Galler, R. Tunnel spoil—New technologies on the way from waste to raw material/Tunnelausbruch—Neue Technologien für den Weg vom Abfall zum Rohstoff. Geomech. Tunnelbau 2014, 7, 402–410. [[CrossRef](#)]
 5. Voit, K.; Kuschel, E. Rock Material Recycling in Tunnel Engineering. Appl. Sci. 2020, 10, 2722. <https://doi.org/10.3390/app10082722>
 6. <https://www.jpautoceste.ba/pocitelj-zvirovici/>, datum preuzimanja: 24.02.2024.
 7. Spahić E., Izvještaj o ispitivanju kamena br.286/20, SAC Testing & Consulting d.o.o. Društvo za projektovanje, kontrolu, kvaliteta i konsalting, 2020., Sarajevo, str. 3.
 8. Smjernice za projektovanje, građenje, održavanje i nadzor na putevima, Knjiga II: Građenje, Dio 2: Posebni tehnički uslovi, Direkcija cesta FBiH, Sarajevo 2005, str.436-447.
 9. Babajić E., Izvještaj o mineralno-petrografskoj i hemijskoj analizi frakcionisanog kamenog agregata iz iskopa tunela „Počitelj“, Počitelj, Rudarsko-geološko-građevinski fakultet Univerziteta u Tuzli, februar 2020.
 10. Spahić E., Izvještaj o usvojenom sastavu mlaznog betona C25/30, XC2, Dmax8, C10.2, S4, br. 351/20, SAC Testing & Consulting d.o.o. Društvo za projektovanje, kontrolu, kvaliteta i konsalting, 2020., Sarajevo, str. 1-10.

EXPLOITATION AND PROCESSING OF TECHNICAL STONE FROM QUARRIES PLJEŠEVAC NEAR KISELJAK

Mujo Valjevac¹, Ekrem Bektašević², Kemal Gutić³, Noris Sakić⁴, Denijel Sikira⁵

ABSTRACT

Today, technical stone is a material that is used on a huge scale, and its annual consumption in the world is expressed in thousands of millions of tons. The demand for construction, such as houses, hospitals, hotels, schools and so on, has expanded, especially in developing countries. One of the key elements that increases the demand for such products is the numerous government infrastructure projects and maintenance programs. All levels of government in Bosnia and Herzegovina strive to implement good infrastructure, because in this way they enable trade, support industry, connect workers with jobs, and in this way bring hope for prosperity in these areas. The paper gives a brief overview of the production and processing of dolomite from the "Plješevac" quarry near Kiseljak as a positive example from the practice of "production and processing from raw material to final product".

Key words: quarry, dolomite, aggregate, technical stone, exploitation, processing

INTRODUCTION

If there was no production and processing of technical stone, there would literally be nothing around us. There would be no modern roads, ports, airports, buildings, schools, houses, hospitals, etc. If we know that for the construction of an average house, about 400 tons of aggregates are needed, for an average school, about 3,000 tons, for a kilometer of highway, about 30,000 tons [1], then it is clear to us what an important role the production and processing of technical stone plays both in our country and in the world.

Currently, about 90% of the total production of stone aggregates in Europe comes from natural sources, from quarries and gravel pits. The remaining 10% of European aggregate production comes from marine deposits, by recycling industrial waste such as slag and ash, and by recycling construction waste [2], (Figure 1).

¹ graduate mining engineer, "Baumit Kamen" d.o.o. Sarajevo, Mujo.Valjevac@baumit.ba

² Ph.D. graduate mining engineer, "PPG" d.o.o. Sarajevo, bektasevic.ekrem@gmail.com;

³ Full professor, University of Tuzla, Faculty of Mining, Geology and Civil eng, kemal.gutic@untz.ba

⁴ Assistant, University of Tuzla, Faculty of Mining, Geology and Civil eng, noris.sakic@untz.ba

⁵ "FM INŽENJERING" d.o.o. Sarajevo, denijal.sikira@gmail.com

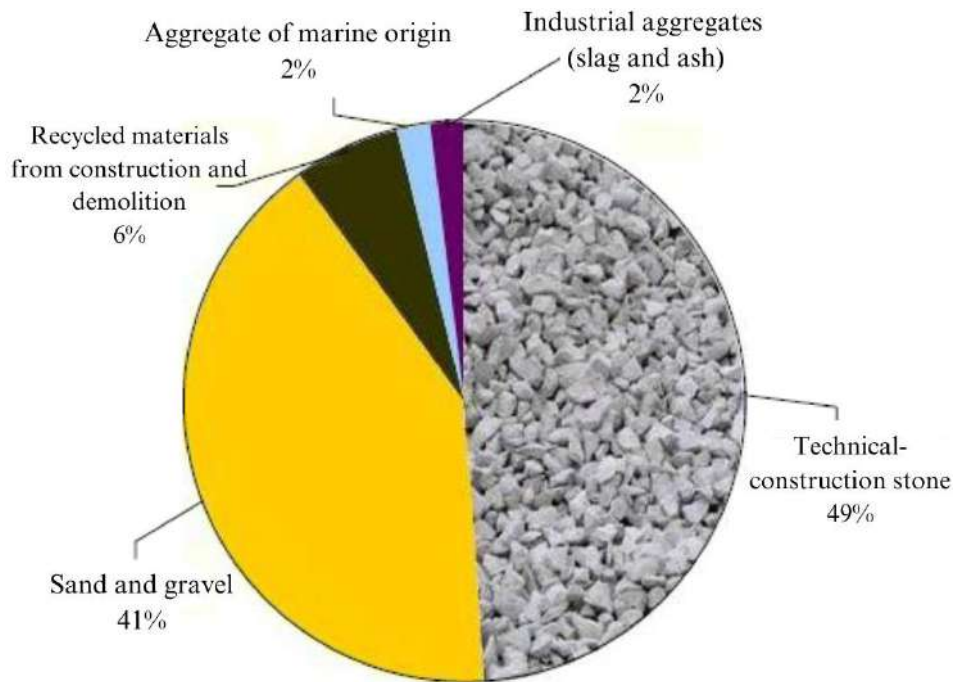

Figure 1. Production and sources of stone aggregates in Europe [2]

The European aggregates industry produces three billion tons per year, worth more than 30 billion euros. These aggregates are produced in 26,000 quarries across Europe, which belong to around 15,000 companies, so the production and processing of aggregates mainly consists of small and medium-sized companies. Every European citizen consumes about six tons of aggregates annually, and the industry of production and processing of technical stone employs about 187,000 people, so this sector is by far the largest non-energy extractive industry in Europe [1].

Given that Bosnia and Herzegovina is a developing country, the role of the construction industry should ensure rational, economical and fast construction of construction facilities [3]. In the Federation of Bosnia and Herzegovina, there are no precise data on the number of quarries that are in operation [4]. In the territory of the Federation of Bosnia and Herzegovina, 11 different mineral raw materials are currently being exploited, which are used as technical - building stone. These are: gravel, quartz diorite, quartz keratophyre, diabase, peridotite (Iherzolite), spilite, limestone, dolomite, carbonate breccias, amphibolite and marble [3]. Limestones and dolomites belong to sedimentary rocks, while the rest are of magmatic origin.

Dolomite is a monomineralic carbonate rock composed of dolomite minerals. Chemically pure dolomite contains 30.41% CaO, 21.86% MgO and 47.83% CO₂. In the form of admixtures in dolomite can be: calcite, magnesite, siderite, opal, chalcedony, clay minerals, gypsum, quartz and other minerals. Although dolomites have a wide range of applications: the industry of refractory materials, as melters in ferrous metallurgy, in the production of glass, cement, paper, paints and varnishes, rubber, in the pharmaceutical and ceramic industries in the territory of the Federation, it is exploited in 33 deposits and used as a technical-construction stone for making concrete and concrete accessories. The ratio of total balance reserves of dolomite mineral raw material by individual cantons is shown in Figure 2.

The "Plješevac" quarry near Kiseljak is a dolomite quarry that has been in existence since 1963 until today in a smaller or larger production capacity. Currently, the Plješevac quarry is one of the largest quarries in FBiH due to its annual production and processing of technical stone (dolomite) of approximately 650,000 tons. The location of the Plješevac surface mine is located about 15 km southeast of Kiseljak and about 25 km from Sarajevo, west of the settlement Rakovica on the Plješevac hill. Traffic and transport conditions are quite favorable considering that the deposit is connected to the regional asphalt road Sarajevo-Kiseljak. The connection with the regional road implies two roads 2.0 km long, each of which consists of a good macadam road of 0.5 km and an asphalt road of 1.5 km. The narrower location of the Plješevac dolomite deposits belongs to the village of Rudnik at a distance of approx. 2.0 km. The villages of Tulica, Stanjevac, Košelji and Zabrđe are located in the wider area of the deposits. The location of the quarry is isolated from the surrounding settlements. The area around the surface mine is covered, for the most part, by coniferous forest, much less by meadows. The surrounding hills prevent the dispersion of

solid dust particles over wider areas [5].

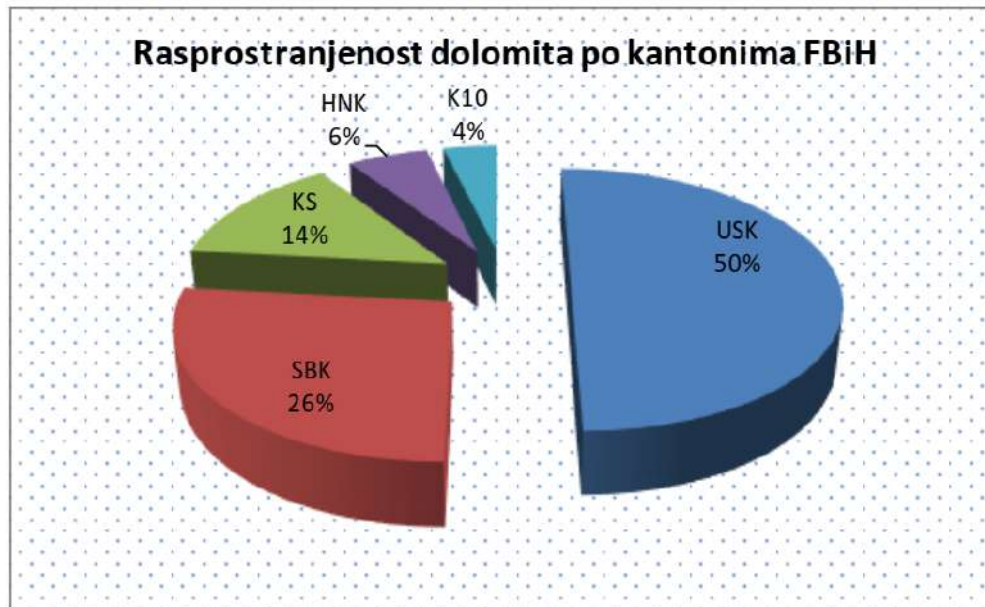

Figure 2. Distribution of dolomite in cantons [3]

The highest elevation of the terrain is 913.0 m, a.s.l. and is located on the site of the Plješevac mountain, and the lowest is 796.0 m above sea level. and is located on the plateau where the separation and accompanying facilities are located as part of the production complex of the Plješevac surface mine near Kiseljak. Figure 3 shows the spatial location of the Plješevac quarry near Kiseljak.



Figure 3. Plješevac dolomite quarry near Kiseljak

1. EXPLOITATION AND PROCESSING OF TECHNICAL STONE FROM QUARRIES PLJEŠEVAC KOD KISELJAK

The surface exploitation of technical dolomite stone at the Plješevac quarry is based on very favorable natural and created technical-technological and other conditions. Decisive influence on the choice of mining mechanization structure at the Plješevac quarry has natural and technical - technological factors.

In natural factors:

- physical and mechanical characteristics of dolomite,
- shape and dimensions of the outline of the quarry and
- terrain topography.

In the technical - technological characteristics:

- the capacity of the quarry and the maximum size of the input piece into the crusher,
- intensity and dynamics of quarry development in terms of plan and height, and location of processing capacities,
- applied technology for exploitation and processing and
- supply of driving energy.

The project solution for the exploitation of dolomite at the Plješevac surface mine adopts the following parameters:

- number of working months in a year..... $N_{mo} = 12$
- number of shifts per day..... $N_{shf} = 2$
- number of working hours in a shift..... $N_{h/shf} = 8$
- effective use of working time..... $k_v = 0,85$
- number of working days in a month..... $N_{wdmo} = 24$

From the stated conditions, it follows that the annual fund of effective working time amounts to:

$$T_g = N_{mo} \times N_{shf} \times N_{h/shf} \times N_{wdmo} \times k_v = 12 \times 2 \times 8 \times 24 \times 0,85 = 3.916,00 \text{ hef/year} \quad (1)$$

The designed hourly capacity of 300 t/hef of the installed plant is realistic and confirmed in the trial operation of the plant, which amounted to 280-350 t/hef. The annual production capacity for the Plješevac dolomite surface mine amounts to:

$$Q_{\text{per year}} = T_g \times Q_{t/h} = 3.916,0 \times 300,0 = 1.174.800,00 \text{ (t/year)} \quad (2)$$

Laboratory testing has determined that the basic mass of the Plješevac quarry is made up of dolomite, while the rest are minerals with a negligible contribution. Table 1 shows data on the chemical composition, while Table 2 shows the physical and mechanical properties of dolomite at the Plješevac quarry near Kiseljak.

Table 1. Chemical composition of dolomite at the Plješevac quarry near Kiseljak

Loss on ignition	CaO	MgO	SiO ₂	Al ₂ O ₃	SO ₃	CO ₂	Na ₂ O	K ₂ O	P ₂ O ₅
46,84 %	32,64%	20,04%	0,24%	0,09%	0,05%	43,95%	0,022%	0,009%	0,003%

Table 2. Physical and mechanical properties of dolomite

Σ_s	Dry compressive strength	25,54 N/cm ²
σ_v	Compressive strength in a water-saturated state	23,26 N/cm ²
g	Frost resistance	0,026 %
χ_d	Specific mass	2,8 g/cm ³ (2,83-2,74)
h	Abrasion resistance	20,99 cm ³ /50cm ²
S	Sulfate and sulfide content	0,00 %
U	Water absorption	0,416 %
χ_z	Volumetric mass	2,63-2,74 g/cm ³

It follows from the previous results that the dolomite of the deposit "Plješevac" has good qualitative characteristics, both in terms of chemical content and physical-mechanical characteristics. Based on these indicators, their spectrum of application was determined: construction-technical stone, stone aggregate for the production of concrete and mortar, for the production of lower bearing layers (buffer) in road construction and as a filler in other industries.

The technology of performing works on the production of dolomite

The conditions of exploitation include the whole of technical and economic components through the synthesis of quantity and quality, position and shape of the deposit, and technical conditions for the use of useful components [6]. The dolomite bed is covered with a thin layer of humus up to one meter thick. Removing the humus cover is done with a crawler excavator or a bulldozer in short steps from top to bottom. The project envisages the following technological phases of the works:

1. Drilling and blasting,
2. Loading of demined material directly into trucks and transport of demined material to the processing plant.

The general peculiarity of this type of exploitation is discontinuity, whereby drilling can coincide with loading and transport. The dynamics of the works are adjusted to the production program so that once the excavation in one excavation zone is completed, the excavation of the next one can be started immediately. Figure 4 shows the loading of demined material on the floor after drilling and blasting.



Figure 4. Loading of materials after blasting on the floor

Technology of performing works on dolomite processing

"Baumit Kamen" d.o.o. which carries out the exploitation and processing of dolomite at the "Plješevac" quarry near Kiseljak, installed a modern separation of crushing and classification within the quarry. Figure 5 shows the technological scheme for the processing (crushing and grading) of trench dolomite at the "Plješevac" separation, while Figure 6 shows the modern crushing plant installed at the quarry.

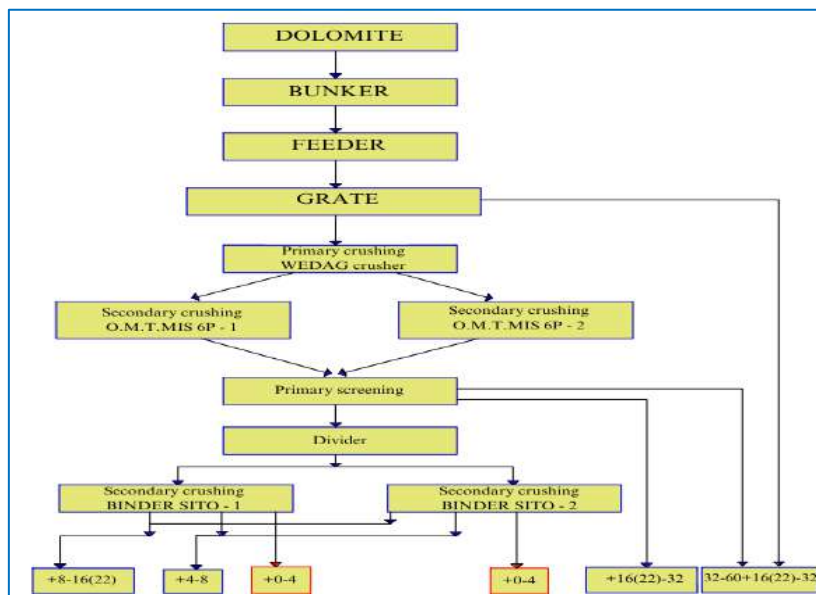

Figure 5. Technological scheme of trench dolomite processing at the separation "Plješevac"



Figure 6. Dolomite crushing and grading plant at the Plješevac quarry

On separation from trench dolomite after crushing and grading, aggregates of the following coarseness are produced: 0 - 4; 4-8; 8 - 16; 16-32; 32-60 and separated tampon. Table 3 gives an overview of the share of individual products obtained from trench dolomite.

Table 3. Participation of individual products after crushing and classification

0 - 4 (mm)	4 - 16 (mm)	8 - 16 (mm)	4 - 8 (mm)	Separated buffer	Other products	Total (%)
35	12	14	11	16	12	100

The participation of aggregates 4-8 (mm) in the production of concrete mix is negligible, and it was necessary to find a solution for the mentioned aggregate so that they would not be "buried" with it. "Baumit Kamen" d.o.o. Sarajevo, as a daughter of the Austrian company for the production of construction materials, made the decision to build production plants for various types of fillers in 2006, so that aggregates that are not sold directly at the quarry will undergo secondary processing in a new plant located in the immediate vicinity of the quarry.

Baumit's factory in Bosnia and Herzegovina has been in operation since 2008, using its capacities for the production of powder products. Today, over 90% of all powder materials that Baumit places on the BiH market are domestically produced. When it comes to the range of products, Baumit production in Rakovica currently produces over 20 different items in the categories of interior and exterior plasters; ceramic and facade adhesives; screed; masonry mortar; dry compacted concrete mixtures. New products are continuously introduced into production, following all contemporary trends and market needs. With the aim of additional modernization and safe development, Baumit invests year after year in new technologies in production and expansion of infrastructure capacities. To ensure that nothing is left to chance, the Baumit factory has two modern laboratories for the analysis of raw materials and finished products. Professional staff and modern equipment enable at all times an adequate response to challenges in terms of quality and performance analysis of materials and raw materials. Figure 7 shows a modern plant for the production of fillers, which is one of the leading manufacturers of facades and building materials both here and in Europe.

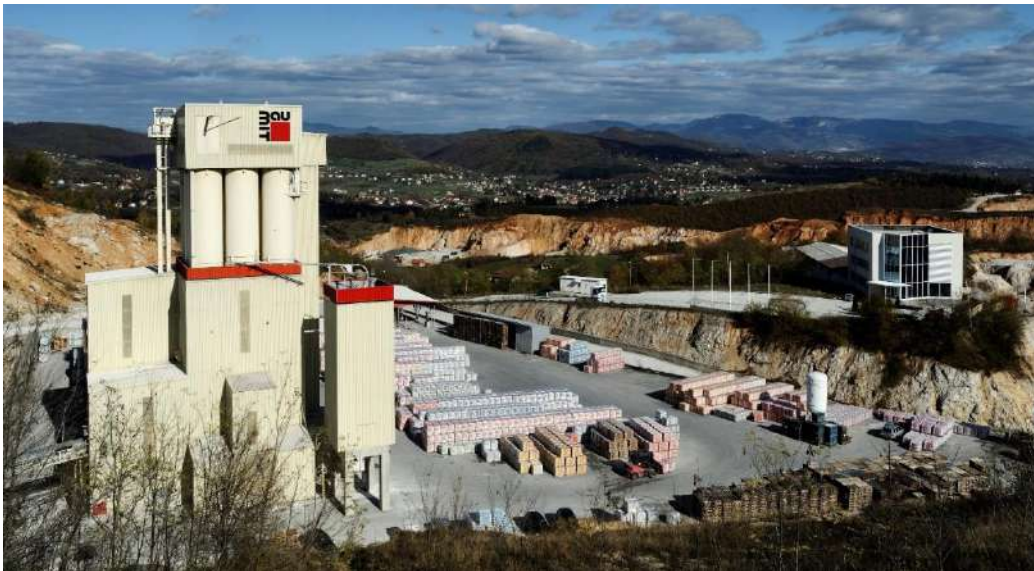

Figure 7. Baumit filler production facilities d.o.o. [7]

CONCLUSION

When we talk about the production of aggregates from a quarry, in most cases we think of the degradation and devastation of a certain relief zone. However, to the extent that the production of aggregates goes "hand in hand" with environmental protection, in that case we have prosperity and development while preserving all the components of the environment.

The planned investments in infrastructure should significantly contribute to the strengthening of both the construction sector and those branches of the processing industry that are closely related to construction, which is in direct correlation to the greater needs of aggregates on the market. The most favorable conditions for the realization of mineral raw materials are where the location of the exploitation site and the market coincide, that is, where the realization is carried out. The "Plješevac" dolomite deposit has a very favorable position, bearing in mind that it is located in a narrow zone of the Sarajevo area, which justifies it as the leading producer of aggregates and all types of dolomite fillers in this area. In particular, it should be noted that Baumit Kamen d.o.o. in its many years of practice, it treats all measures and regulations related to occupational health and environmental protection as part of the technological process.

LITERATURE

- [1] <https://www.aggbusiness.com/feature/mapping-out-future-european-aggregates>, day 31.3.2024.
- [2] Chalkiopoulou, F., Hatzilazaridou, K.: Department of Mineral Resources and Petroleum Engineering, Planning poli-cies and permitting procedures to ensure the sustainable supply of aggregates in Europe, Commis-sioned by UEPG, University of Leoben, 2010.
- [3] Development strategy of the construction material industry of the Federation of Bosnia and Herzegovina for the period 2016-2025. year, Chamber of Commerce/Economics FBiH Federal Ministry of Energy, Mining and Industry, June, 2018.
- [4] <https://www.nkp.ba/u-fbih-kamen-se-vadi-iz-200-ilegalnih-kemenoloma-prirodna-bogatstva-u-dzepovima-divljih-vlasnika/>, downloaded 01.04.2024.
- [5] Additional mining project of the "Plješevac" dolomite surface mine, which was carried out at the Faculty of Mechanical Engineering of the University of Zenica, May 2008..
- [6] E. Bektašević, A. Baraković, J. Konta, Techno-economic analysis of the justification of limestone exploitation in the contoured surface mine "Sokolica" near Zavidovići, Croatian Mining Geological Society Mostar - Mining Geological Bulletin, Mostar December 2010, (page 181 – 189), (ISSN 1840 0299), Chief Editor Josip Marinčić, B.Sc.
- [7] <https://baumit.ba/kontakt/adresa>, downloaded 02.04.2024.

BENCH HIGHT AND SLOPE ANGLE ON LITHIUM ORES OPEN PIT MINES

Tihomir Knežiček¹

ABSTRACT

The fundament of the open pit geometry, both, on metallic and non-metallic mineral raw materials, consists of benches that allow mining operations to be carried out in the contour of the open pit mine. On lithium pit mines, formed benches of a certain height and slope angle, must ensure physical stability of the open mine pit and smooth running of mining work to excavate, load and transport the overburden and mineral resources out of the contour of the lithium open pit mine. The bench height and slope (bank) angle depend on the geotechnical situations, water impact and conditions of utilizing mining mechanization in digging, loading and transporting the overburden and mineral raw material.

Key words: lithium, open pit mine, bench height, bench slope angle

1. INTRODUCTION

Open pit mine geometry is based on the concept of stability of the working area in which the mining operations take place, regardless of the type of ore being excavated. Surface mines are mining facilities that develop in all directions - horizontally and vertically, according to a certain procedure. The basic rule is that works on pit deepening (vertically) can only be realized if the prerequisites for expanding the works at higher levels – benches (horizontally, regardless of the advancing direction) have been met. The open pit development creates the open pit crater (inverted truncated cone) and its contour. The expansion of the works involves the construction of working benches where overburden and mineral raw materials are dug with mining machinery, and the excavated material is transported either to the overburden waste dump or to the mineral raw material landfill or to mineral processing plants. Depending on the characteristics of the rock mass where the lithium ore is integrated, technological processes, among other aspects, impact on the calculation of the bench height and slope. In the case of a loose rock working environment, the material on the bench is dug and loaded with mining machinery, and in the case of solid rocks, the process of drilling and blasting the rock mass is applied, followed by loading into the heavy trucks. Since the diversity of the geological structure of the lithium ore deposit, it is applied surface mining with the deepening to the ultimate pit depth, i.e. to an economically profitable digging depth. The deepening of the surface mine is designed and worked out according to the geometrical analysis results, with primary emphasis on the characteristics of the benches, as well as the characteristics of the ultimate pit slopes, transport paths, mine drainage and other elements in the contour of the open pit mine.

2. BENCH CHARACTERISTICS AT THE LITHIUM ORE OPEN PIT MINE

The surface mine floor represents the area where overburden and lithium ore are dredged. It is characterized by the volume of the block that is excavated at the floor level, and the block (in m³) is defined by the height of the floor, the angle of inclination of the floor and the width of the catch, i.e. the digging radius of the excavator digging the material.

PhD, Full professor, University of Tuzla, Faculty of Mining, Geology and Civil eng, tihomir.knezicek@untz.ba

The layout of floors in the open pit contour is determined by geometric analysis or software methods based on the Lerchs-Grossmann, or similar, algorithm. The prerequisite for surface exploitation is that the floors are stable and that the slope of the floors does not collapse. There are three global influencing factors on slope stability: geological and engineering geological, hydrogeological and mining-technical.

2.1 Geotechnical stability of bench slope

The geotechnical stability of the bench slope primarily depends on the lithological composition of the rock mass, rock strength, fractures and distribution layer structure of the material. Disturbance of geotechnical stability results in the bench failure by sliding of material in the bench slope, which can cause human casualties, injuries to workers, damaging mining machinery and stoppage of production processes until the bench / benches are reconstructed and the collapsed material is replaced. The duration of the reconstruction mining works depends on the number of destabilized benches and the sliding surface width. For failure of one bench, reconstruction takes about 7 days, and in case of sliding of several benches (which also happens during the exploitation of lithium ores), reconstruction takes several months.

At Rio Tinto's borates and lithium open pit mine (picture 1), located 145 km from Los Angeles, USA, in 1998, the sliding of benches caused collapse of about 39 million tons of rock material, which had significant multi-year negative impacts on mining operations in the open pit mine. The causes of bench sliding were the bench geological structure, the influence of underground and surface water and to steep bench slopes³.



Figure 1. Landslide at the Rio Tinto open pit mine in the Mojave Desert in the Kern region near Los Angeles in 1998

In the literature, authors specify a number of mineral deposit groups and subgroups classifications in accordance to the slope stability, and lithium ore deposits (suitable for open pit mining) are composed of hard rocks⁴ with the strength from 800 N/cm² to 8000 N/cm² and unconsolidated rocks whose strength is less than 800 N/cm². Data of the rock strength are obtained through laboratory testing of the physical and mechanical rock properties. As a result of the disturbance of the bench slope stability, sliding of the rock mass of the bench slope occur, and the sliding types are classified according to the spatial movement of masses - sliding surfaces from the higher level of the bench to the lower one, and all the way to the bench floor where digging and transport are carried out. In order to preventively act, slope stability monitoring and analyses are carried out for different types of fracture surfaces and for the designed bench height and slope angle.

³ Nutakor D., Asbury N., Zavodni Z., Back analysis of Rio Tinto Borates and Lithium Mine north wall failure, konferencija Slope Stability 2022, Tucson, SAD, 2022.

⁴ Popović N. Naučne osnove projektovanja površinskih kopova, poglavlje 2, Sarajevo, 1984.

2.2 Mining machinery

The sequence of technological processes at the open pit mine is determined with the aim of extract the considered mineral raw material or dig-out the overburden. Technological processes include drilling and blasting (in case of hard rocks that cannot be excavated by mining machinery), digging, loading and transportation. Digging is done with dig bucket excavators (hydraulic bucket excavators or rope electric shovels), which at the same time load the excavated material into transport vehicles (most often a truck).

Bucket shovels are produced with an electric drive, and in rare cases they have a diesel drive engine - if they are smaller excavators with a bucket volume of 3 to 4 m³. They can dig in material from loose to very hard and abrasive rock. At lithium ore open pit mines, it is expected that the same mining machinery (excavators and trucks) will be utilised for digging and transporting overburden and for digging and transporting mineral raw materials.

Digging is usually done from the ground standing level of the excavator, i.e. on the bench ground, and in such case, hydraulic bucket excavators with a shovel loading bucket - classic or bottom dump buckets are applied - picture 2. If digging is done below the ground level (so-called downward digging), then hydraulic bucket excavators with an inverted bucket, often called backhoes, is applied - picture 3. Hydraulic excavators can dig along a variable digging trajectory chart, and the dimensions of the digging reach depend on the manufacturing i.e. technical and technological excavator's performances.



Figure 2. Loading material into a truck with a hydraulic excavator with a folding bucket



Figure 3. Loading material with a hydraulic excavator with an inverted bucket into a truck - bottom digging

Figure 4 shows a classic combination of a hydraulic excavator with a bottom dump bucket in the start position for digging the bench and discharging rock material into the truck, as well as the digging trajectory chart. The unit proportions of the excavator, whose bucket volume is 16 m^3 and the position of the associated truck, show the performance of digging depth and height and digging reach (ft, m). The example shows the efficiency of digging 11.5 m high of the bench⁵.

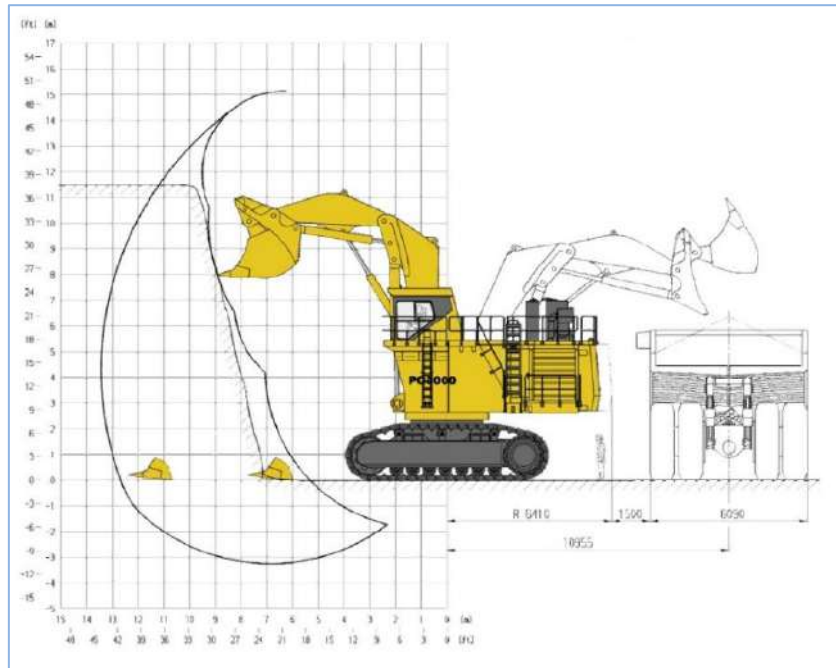

Figure 4. Hydraulic excavator performances for a bench height of 11.5 m and the associated truck capacity of 165 t

The bucket shovel digs exclusively at the ground level of the excavator, utilizing bottom dump buckets. The operating layout is very similar to digging with hydraulic bucket excavators (working in a block, loading into a truck), and they have an arc form digging trajectory chart. Although they use steel ropes to control the working organs, decades of experience in the operation of shovels, have shown that this type of excavator is extremely durable, reliable, with a low number of downtimes and have low maintenance costs. The bench high digging depends on the technical and technological performance of the shovel, and the usual bench height is up to 16 m .



Figure 5. Loading of material with a rope shovel into a truck

⁵ Catalogue Komatsu hydraulic excavator PC3000 capacity 16 cu.m .

Figure 6 shows the classic combination of a shovel in the digging position and discharging excavated materials into the truck, as well as the arched digging trajectory chart. The unit proportions of the shovel, whose bucket volume is 16 m³ and the position of the associated truck, show the performance of digging depth (up to 1 m) and digging height (16.3 m), digging reach of 24.5 m and bench height of 12.2 m.

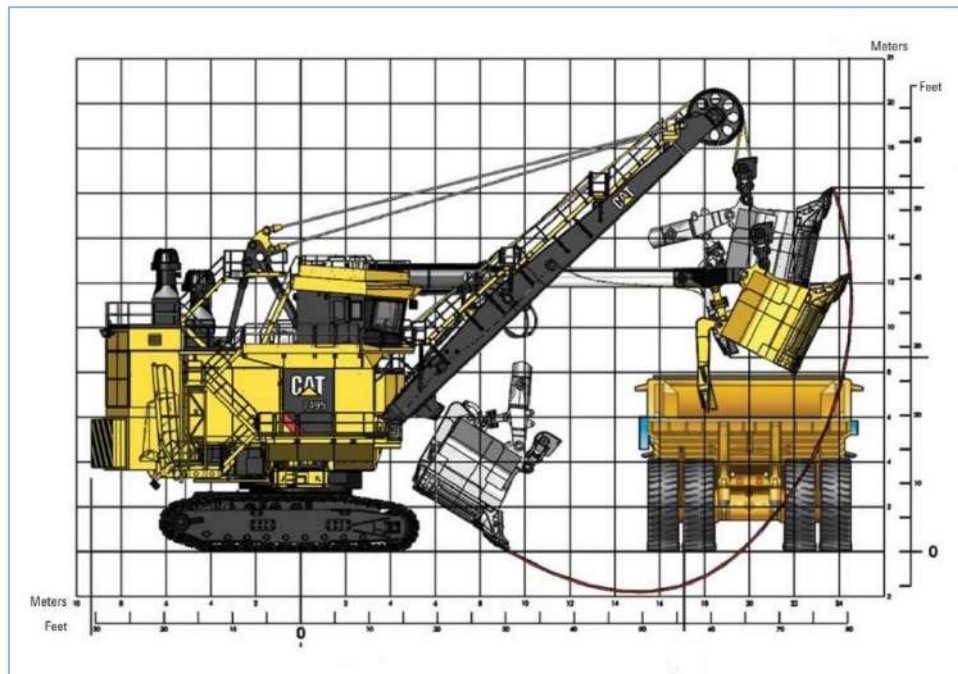

Figure 6. Performance of the shovel for a maximum bench height of 12.2 m and the associated truck

2.3 Bench parameters without blasting

The bench parameters without blasting are the height, slope and length of the bench. Two groups of parameters influence the choice of bench height in a lithium ore open pit mine - basic and secondary.

a. Basic parameters

- geomechanical characteristics of the rock massif where lithium ore is mined,
- the presence of water in the massif and
- (maximum) excavator's digging height.

b. Secondary parameters

- the rock strata formation,
- deposition of lithium ore deposits,
- the direction of mining front advance,
- advancement of the mining block excavation in relation to the deposit's strike and dip.

Taking into account the digging height of the bucket excavator, variable bench heights can be considered, depending on the technical-technological performance of the excavator. From the point of view of the available mining equipment and transport conditions, it is advisable to choose a higher bench height, since in this case the number of benches, the number of equipment shiftings and the time of shifting equipment along the benches, the length of transport is shortened (transportation cost takes up to 60% of the mining costs⁶), which in any case results in cost reduction, i.e. increasing the profitability of lithium ore exploitation. On the other hand, in working environments where selective mining is applied, i.e. where is nonstandard or scattered disposition of minerals in the deposit, which is usually the case with lithium ores, then a more acceptable option is lower bench heights. It is expected that the bench height in lithium

⁶ <https://www.linkedin.com/pulse/cost-calculations-mine-planning-shyamal-bag>

ore open pit mine does not exceed 12 m and that the bench slope angle ranges from 70° - 80° . The bench length, i.e. horizontal length of the working benches of the pit mine, depends on the length of the mining front operations, however, it is limited by the horizontal dimension of the pit contour and the positions of the ultimate pit slopes at the mine.

In an intention to work with higher bench heights, the potential risks that occur when digging with the full - maximum digging height of the excavator must be taken into account. The first risk is the collapsing of rock material positioned near the top of the bench, and the second risk is the suddenly reduced digging force when the excavator bucket exits the bench slope.

The optimal bench parameters at the lithium ore open pit mine are shown in Figure 7, which is not a rule because the bench parameters depend on several influential factors that were previously discussed. The example illustrates a bench height of 10 m, a bench slope angle of 70° to 80° and a block width of 10 m. The bench height, for example, is synchronised with the technical and technological parameters of the hydraulic excavator (for example RH 75 - 7.6 m^3 to 10 m^3 bucket volume) which digs and discharge the rock material, and the truck (for example FAUN 85.5 - capacity 77 t) that after loading, transports excavated material. The compatibility of the excavator-truck system refers to the capacities of the excavator and the load capacity of the truck, the physical sizes of the machines and the excavator's operating parameters, which is a matter of special calculation procedure. On average, for a complex with the specified performance, the excavator performs loading / discharge in 8 cycles, which takes about 5 minutes in total. The picture 7, cross-section A-A, shows the influence of the change in the bench slope angle (slope angle option 70° and 75°) on the position of the associated excavator's digging trajectories charts that excavates a 10 m bench high at ground level.

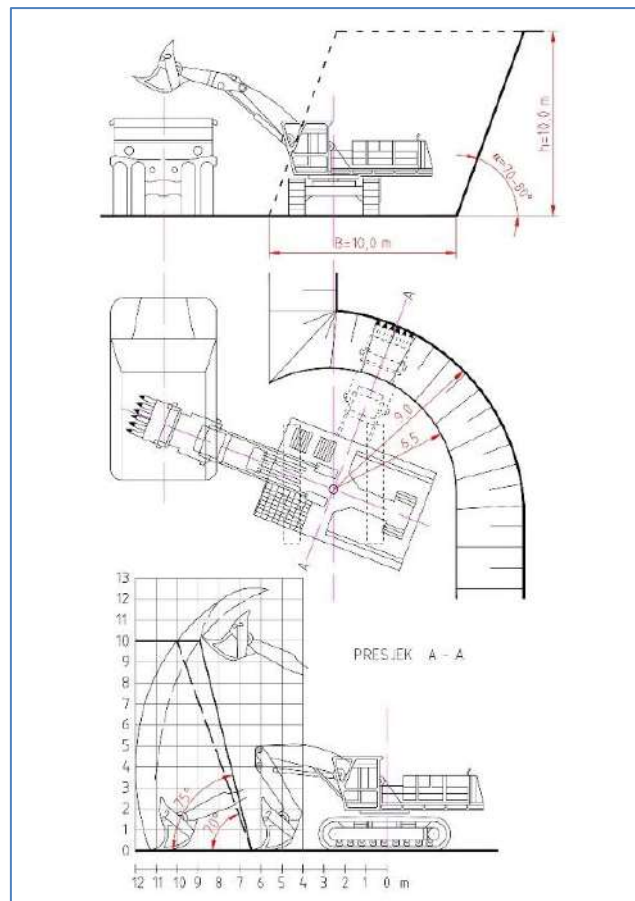

Figure 7. Bench parameters, mechanization position and digging trajectories chart for different bench slope angles

2.4 Bench parameters with blasting

Blasting by explosive on the benches can be done for the presplit blasting the material that will be subsequently excavate by mining machinery, or by production or secondary blasting, when the bench turns

from a solid monolithic status into an incoherent mass consisting of different granulations of pieces of the rock massif. The parameters of the bench that are blasted for presplitting differ slightly from the parameters of the bench that are excavated by mining machinery.

The bench parameters with production blasting of the rock massif are the bench height, the bench slope angle and the bench length, and after blasting, the width of the collapsed material at the face. Three groups of parameters influence the bench height selection at a lithium ore open pit mine where drilling and blasting operations are needed.

- a. Basic parameters
 - geomechanical properties of rock mass being blasted.
- b. Secondary parameters
 - performance of the excavator for loading (digging) broken mass and discharge the material into the truck,
 - safety distances of blasted material pile from transport communication,
 - the rock strata formation,
 - deposition of lithium ore deposits,
 - the direction of mining front advance,
 - advancement of the mining block excavation in relation to the deposit's strike and dip.
- c. Parameters of drilling and blasting works
 - characteristics of the surface blast patterns (spatial distance between boreholes),
 - blast hole depth and hole inclination and
 - type of explosives charges and method of filling the blast hole (with tamping and intermediate filling the hole with clay).

Calculation of drilling and mining works on the bench is a special engineering calculation procedure.

After the blasting process, the original bench height is reduced due to spreading - sinking of the broken material towards the free surface of the bench slope, and this directly increases the working area width, and thus the bench block. The minimum bench height should meet the condition that the excavators' bucket can be filled in one pass - filling from the bottom up, which primarily depends on the excavators' performances and the stability of ground floor where the excavator discharge rock mass. Blasted material is loaded with excavators (at the ground level) into trucks. During the lithium ore exploitation, carried out in hard rocks, where the drilling and blasting processes are unavoidable, the fundamental bench parameters consider the bench parameters before blasting rock mass.

CONCLUSIONS

Lithium ores open pit mining is based on the pit mine geometry, which is primarily defined by the bench height and the bench slope angle in the contour of the pit mine. Three groups of influential factors impact to the calculation of the bench height and bench slope angle. Those are geotechnical conditions of the working environment, the presence of groundwater and surface water and the performance of digging - loading and transport machinery. The usual combination is digging and loading rock material with shovels into trucks, whose technical and technological performances allow digging the optimal bench height of 10 m, the bench slope angle of 70° to 80° and the related block width of 10 m, within the condition that excavation is performed at the ground level of the excavators. The bench length is limited by the position of the mining front in-between one final pit slope of the final pit slope at the opposite end of the mine. Engineering calculations for specific working conditions and for the specific mining mechanization applied, results in the precise open pit mine geometry for lithium ores, i.e. precise values of bench height and slope angle, block width and bench length.

REFERENCES

1. Ausenco Services Pty Ltd, Technical report on the feasibility study for the Sonora lithium project in Mexico, South Brisbane, Australia, 2018.
2. Balasubramanian A., Rock blasting for mining, Technical Report, Centre for Advanced Studies in Earth Science, University of Mysore, Karnataka, India, April 2017.
3. Gandhi R.K., Estimating bench design parameters for open-cut excavation, Masters thesis 5639, School of Mines and Metallurgy of the University of Missouri, Missouri, SAD, 1964.
4. Knežiček T., Computer aided opencast mine planning for steeply dipping bedded deposits, Master thesis, Indian School of Mines, Dhanbad, India, 1989.
5. Knežiček T., Nurić S., Osnove površinske eksploatacije mineralnih sirovina, Tuzla, 2015.
6. Kose H, C.O. Aksoy, A. Gönen, M. Kun, and T. Malli, Economic evaluation of optimum bench height in quarries, The Journal of The South African Institute of Mining and Metallurgy, February, 2005.
7. Laurich R., Planning and Designing of Surface Mines, Surface Mining 2nd Edition, SME, Kennedy B.A. editor, Baltimore, 1990.
8. Nutakor D., Asbury N., Zavodni Z., Back analysis of Rio Tinto Borates and Lithium Mine north wall failure, conference Slope Stability 2022, Tucson, SAD, 2022.
9. Popović N., Naučne osnove projektovanja površinskih kopova, NIŠRO Oslobođenje, Sarajevo, 1984.
10. Simonović M., Bageri I, Beograd 1987.
11. Web https://bacanoralithium.com/sonora_lithium_project/default.aspx - the World largest lithium open pit mine.
12. Web <https://www.linkedin.com/pulse/cost-calculations-mine-planning-shyamal-bag> - transport cost in the total mining cost.

HYDROGEOLOGICAL CHARACTERIZATION AND GENESIS OF MINERAL WATER "TESANJSKI KISELJAK"

Dinka Pašić-Škripić¹, Izet Žigić², Đana Zimić³

ABSTRACT

Ensuring the exploitation and use of mineral water "Tešanjski kiseljak" implies the analysis and performance of complex geological, hydrogeological, hydrological, quantitative, qualitative and genetic research, as well as the definition and establishment of high ecological standards in the researched area of the "Tešanjski kiseljak" source, along with exemplary field and laboratory and cabinet analyzes and data processing.

The basic criteria for defining the genesis and regime, hydrogeological relations and protection of mineral waters are geological and geomorphological characteristics of the terrain, climatic and hydrographic conditions, structural-tectonic and hydrogeological characteristics of the terrain, quantitative and qualitative characteristics of the source, existing and potential pollutants of the source, analysis of genetic and hydrodynamic aquifer parameters from which protection zones and source protection measures arise

Depending on the hydrogeological characteristics of the terrain, the relationship between permeable and impermeable rocks, the position of the aquifer in relation to atmospheric and surface waters, recharge conditions, permeability and hydrogeological parameters, the existence of the water body of mineral waters, the renewal of its reserves and the quality of mineral waters depends.

Key words: mineral waters, hydrogeological categorization, structural-tectonic relations, water genesis

INTRODUCTION

The source of "Tešanjski kiseljak" is in the valley of the Raduška river, whose valley stretches in a southwest-northeast direction all the way to lower Srednja Raduša, when it abruptly changes its direction to the east, in the direction of Tešnja. The width of the valley in the area that gravitates to the source is about 100-150 meters and was cut by erosion into relatively soft formations of the ophiolitic melange, while downstream from the source, the Raduša valley was cut into Oligomiocene sediments. The mineral water deposit "Tešanjski kiseljak" belongs to the hydrogeochemical area of mineral and thermomineral waters with CO₂ of the "ophiolitic zone". The hydrogeological characteristics of the investigation area of the source should be observed through the prism of hydrogeological categorization, reionization and function of rock masses, filtration characteristics, crack systems and faults, hydrogeological collectors and isolators, and the directions of movement of underground water, along with the analysis of the complex conditions of the genesis of mineral water. The hydrogeological characteristics of the research area are conditioned by very complex stratigraphic-tectonic and genetic relationships. For this reason, underground water and currents move from greater depths through fault zones and larger cracks and appear on the surface in cracked rock masses. The primary and actual collectors are probably on the large depths, and all analyzes point to Triassic limestones. The system of cracks in the diabase-hornblende formation is connected to secondary faults perpendicular to the direction of the primary fault zones, and the springs appear on the surface as overflow springs. The movement of groundwater in a porous environment is very complex due to the fact that in such massifs, groundwater is free level and moves along the line of least resistance, i.e. privileged directions or faults.

¹Full professor RGGF, Tuzla, Univerzitetska 2, dinka.pasic@untz.ba

²Professor emeritus, RGGF, Tuzla, Univerzitetska 2, izet.zigic@untz.ba

³Bachelor of Geology, GeoAvas d.o.o., djanas.zimic@hotmail.com

1. GEOLOGICAL STRUCTURE AND TERRAIN TECTONICS

The geological structure and tectonic relations of the research area are given according to the data of OGK 1:100,000 sheet L 34-121 Zavidovići and Tumač, p. 1-47, Savezni geološki zavod, Belgrade, authors Olujić, J., and Coauthors, 1973, and OGK 1:100,000 L 33132 Teslić and Tumač, p. 1-58., Savezni geološki zavod, Beograd, authors Olujić, J., and Coauthors, 1981. Within the broader and narrower area covered by the geological map, the terrain is predominantly built of Jurassic, Jurassic-Cretaceous, Tertiary and Quaternary formations.

Mesozoic or Jurassic deposits are made up of masses of ophiolites and mélanges, and are primarily represented by large masses of ultrabasic rocks such as peridotites, serpentinites, amphibolites, dolerites, diabases, metadiabases, shale and sandstone complexes, tuffs, carbonate rocks and conglomerates. Jurassic-Cretaceous and Cretaceous deposits are represented by clastic and carbonate sediments, such as conglomerates, breccia limestones, marls, marly limestones and less often limestones with conglomerates, etc. Cenozoic deposits are represented by Paleogene flysch sediments and Neogene Tortonian limestones and clastites. The Quaternary is represented by various types of sediments: terrace, alluvial and slope.

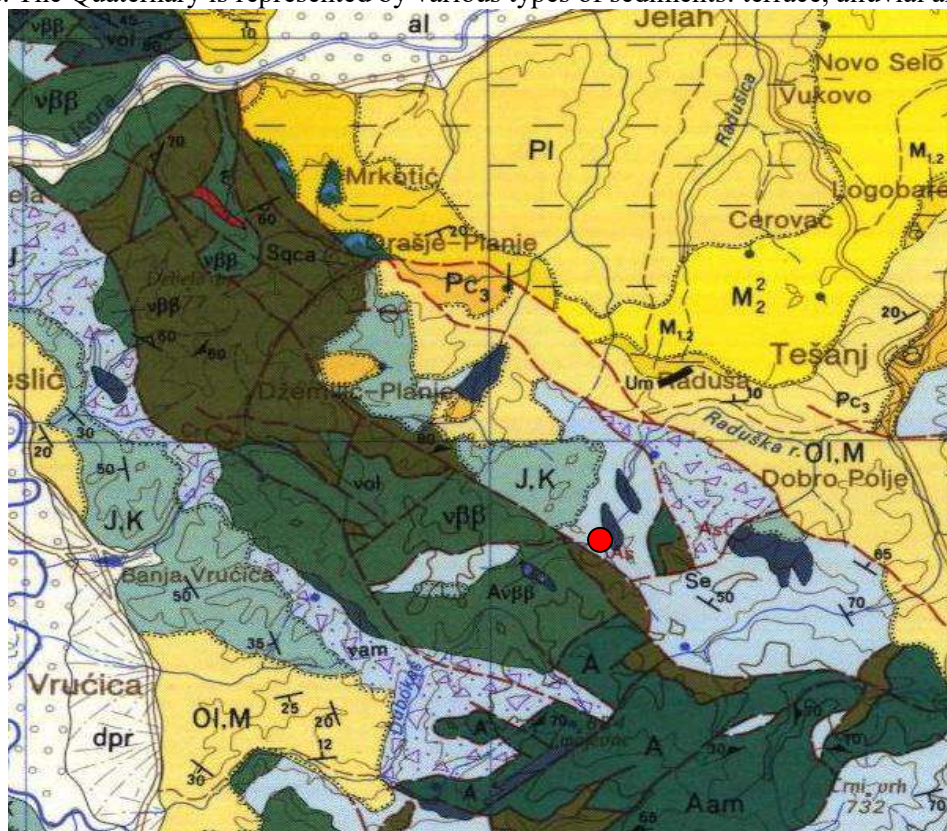

Figure 1. Geological map of the wider area of Raduša 1:100,000 (OGK list Teslić)

From a structural-tectonic point of view, the terrain around Raduša, according to the interpreter of the OGK sheets Teslić and Doboj, belongs to the structural-facies unit Central-ophiolitic melange, i.e. the Doboj block. The lowest member in this block is the ophiolitic mélange (J). Jurassic-Cretaceous, Paleogene and Neogene sediments lie discordantly over the sedimentary members of the melange. The wider area of Raduša is characterized by complex and insufficiently studied structural-tectonic relationships. Among the more important disjunctive structural forms in these areas, the fault that stretches from Oraš Planje through Raduša to Dobro Polje is assumed. In addition to the mentioned fault in this area, the presence of several smaller diagonal and transverse faults is assumed, among which the most important fault is in the valley of the Raduška river, along which mineral waters and CO₂ circulate. The composition of the melange includes sediments of the oceanic crust, then ultrabasic rocks that appear as olistoliths, as well as different basic rocks: spilites, gabbros, diabases, gabbrodiabases, dolerites, peridotites, serpentinites and others. It is interesting to note that here we do not have olistoliths from Mesozoic limestone formations from the rim of the melange basin (trough). The relations between the sedimentary formations of the oceanic crust and the igneous rocks are tectonized without primary contacts, and the character of their boundaries is olistolithic. Sedimentary formations include greywacke sandstones, multicolored clays, conglomerates and

less commonly cherts. The relationships of these different lithological members are irregular - chaotic, so that the primary relationships or structures in them cannot be reconstructed.

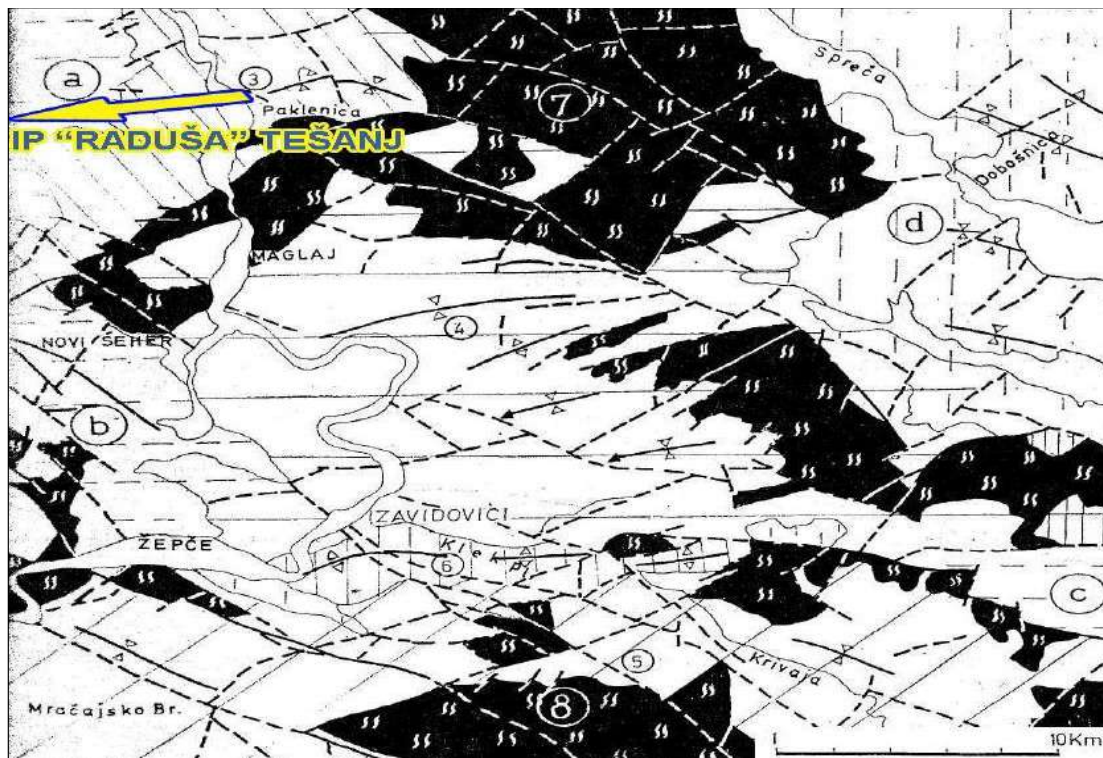

Figure 2. Tectonic map sheet Zavidovići OGK R 1: 100000 (Olujčić, J., and Coauthors, 1973);

2. HYDROGEOLOGICAL CHARACTERISTICS OF THE BROAD RESEARCH AREA

The hydrogeological characteristics of the research area should be observed through the prism of hydrogeological categorization, reionization and function of rock masses, filtration characteristics, fissure systems and faults, hydrogeological collectors and isolators, and groundwater movement directions.

The hydrogeological characteristics of the research area are conditioned by very complex stratigraphic-tectonic relationships. For this reason, underground water and currents move from greater depths through fault zones and larger cracks, and appear on the surface in cracked rock masses. The primary and actual reservoirs are probably at great depths, and all analyzes indicate Triassic limestones. The system of cracks in the diabase-hornblende formation is connected to secondary faults perpendicular to the direction of the primary fault zones, and the springs appear on the surface as overflow springs. The movement of groundwater in a porous environment is very complex due to the fact that in such massifs, groundwater has a degree of freedom and moves along the line of least resistance, i.e. along privileged paths or faults (turbulent regime) and through the fractured collector system (laminar micro-regime). Looking at the hydrogeological characteristics of the narrower research area, it can be seen that potential water collectors are in more or less cracked rocks of the volcanogenic-sedimentary complex. According to the drilling works carried out so far, it has been established that it is a system of microcracks with complicated hydraulic relations and connections of a wider area.

The hydrogeological categorization and functions of rocks in the Raduša area was made on the basis of water-bearing capacity, that is, the ability of the rock to leak, accumulate or release groundwater. Based on the above criteria, two categories of rocks were distinguished in the studied terrain: permeable rocks and impermeable rocks.

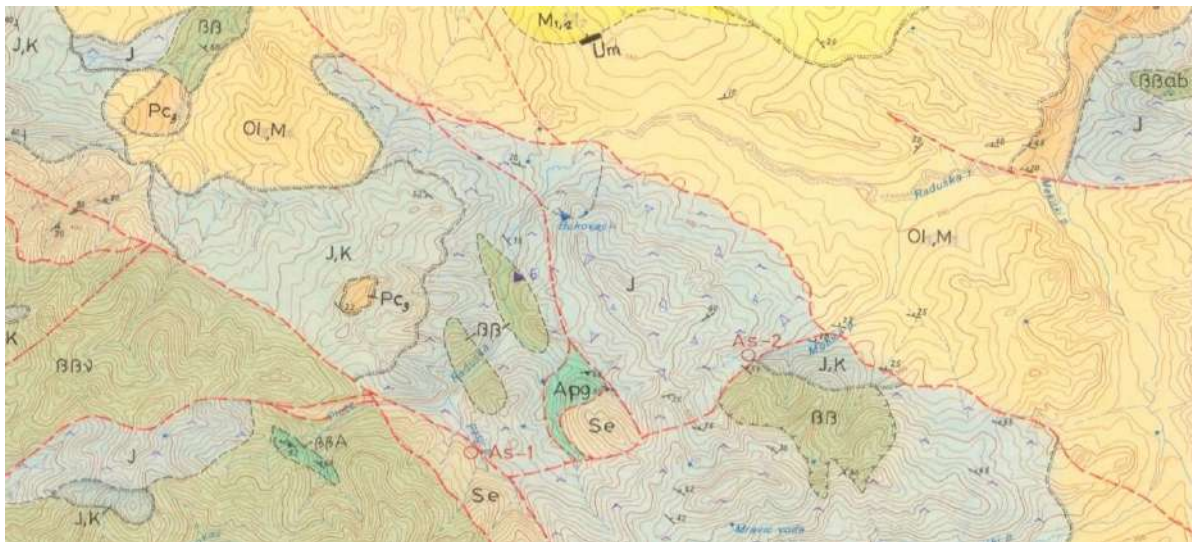

Figure 3. Hydrogeological map of the surroundings of Raduša (Federal Geological Institute of SFRY)

3. GENESIS OF MINERAL WATERS

Hydrogeological mapping of the terrain of the wider and narrower area "Tešanjski kiseljak" was carried out during the development phase of the Project for detailed geological and hydrogeological investigations of mineral waters in the Tešnja area. Hydrogeological mapping was carried out on a scale of 1:25,000 and 1:5,000. During the mapping, hydrogeological categorization and rezoning of rock masses was carried out, geomorphological forms were recorded, all water phenomena and objects, assumed directions of groundwater flow, and hydrogeological conditions of recharge and discharge of groundwater reservoirs were registered. Previous hydrogeological research, and especially based on the results obtained by exploratory drilling during the last four decades, concluded that the hydrogeological characteristics within the investigation area of the spring "Tešanjski kiseljak" in Gornja Raduša are conditioned by very complex stratigraphic-tectonic relationships. For this reason, groundwater also moves in transit currents from greater depths through fault zones and larger cracks and appears on the surface in cracked rock masses. The primary and actual hydrogeological collectors are probably at great depths, and all analyzes point to Triassic limestones that have their surface distribution concentrically in the environment around the "Tešanje Neogene Basin" at a distance of ten kilometers. Crack systems within the diabase-rose formation, or ophiolite melange, are connected to secondary faults perpendicular to the directions of primary fault lines and fault zones, as well as to the directions of thrust structures, and groundwater sources using such pre-induced directions appear on the surface of the terrain as overflow sources.

The movement of groundwater in such a broken porous environment is very complex due to the fact that groundwater has a free level and moves along the line of least resistance, i.e. along privileged paths or faults (turbulent regime) and through the fracture collector system (laminar regime). Looking at the hydrogeological characteristics of the narrower research area, it can be seen that potential hydrogeological water collectors are positioned in more or less fractured rocks of the ophiolitic melange, i.e., the latest research has confirmed a slightly more significant water abundance within the degraded and cataclased breccia complex of mostly diabase-amphibolite petrographic composition.

NEPROPUSNE STIJENE		PROPUSNE STIJENE			
FRAKCIJA NEPROPUSNE POROZNOSTI	FRAKCIJA NEPROPUSNE POROZNOSTI	FRAKCIJA PROPUSNE POROZNOSTI	FRAKCIJA PROPUSNE POROZNOSTI		
PRETEŽNO NEPROPUSNE	SLABA NEPROPUSNA POROZNOST	SLABA NEPROPUSNA POROZNOST	PRETEŽNO PROPUSNE	PRETEŽNO NEPROPUSNE	PI LAPORCI, LAPORI I JAKO PJEŠKOVITI LAPORI
SLABA NEPROPUSNA POROZNOST	PRETEŽNO NEPROPUSNE	PRETEŽNO NEPROPUSNE	PRETEŽNO PROPUSNE	PRETEŽNO NEPROPUSNE	P _{C3} MASIVNI I BANKOVITI MIKROSPARITI
PRETEŽNO NEPROPUSNE	PRETEŽNO NEPROPUSNE	PRETEŽNO NEPROPUSNE	PRETEŽNO PROPUSNE	PRETEŽNO NEPROPUSNE	ββ SPILITI ββab DIJABAZI I METADIJABAZI ββu DOLERITI ββA DIJABAZ-DOLERIT-AMFIBOLITSKE STIJENE DEGRADIRANE BREČE NAVEDENIH LITOLOŠKIH ČLANOVA
PRETEŽNO NEPROPUSNE	PRETEŽNO NEPROPUSNE	PRETEŽNO NEPROPUSNE	PRETEŽNO PROPUSNE	PRETEŽNO NEPROPUSNE	² M ₂ SLABO VEZANI KONGLOMERATI, LAPORCI, LAPORI I RIJETKO GLINE M _{1,2} LAPORCI, KREČNJACI, PODRIJEĐENO PJEŠČARI, UGALJ (GLAVNA UGLJENA ZONA) OI, M KONGLOMERATI, PJEŠČARI, PODRIJEĐENO LAPORI I GLINE, UGALJ (PODINSKA ZONA) J, K LAPOROVITI MIKRITI I LAPORCI
PRETEŽNO NEPROPUSNE	PRETEŽNO NEPROPUSNE	PRETEŽNO NEPROPUSNE	PRETEŽNO PROPUSNE	PRETEŽNO NEPROPUSNE	Se SERPENTINITI KOMPAKTNE J BREČE, PRETEŽNO DIJABAZNE, RIJETKO GRAUVAKE, GLINCI I SKRILJCI

Figure 4. Hydrogeological categorization of the research area Gornja Raduša -Tešanj (Vidačić, M.M., 2022)

By analyzing the swollen core material from previous and recent drilling works, it can be concluded that these are systems of microcracks with complex hydraulic relationships and connections, and as such they can be viewed as hydrogeological collectors of the transit type, and to a lesser extent as more significant accumulation spaces. This conclusion is based on the previous exploratory drilling in the immediate vicinity of the production facilities of Zema d.o.o. Tešanj in the flow zone of the Raduška River especially refers to the hydrogeological profile of the exploration and exploitation wells IBR-1/2002, IBR-5/2017-18, while for the aquifer in which the exploration and exploitation wells IBR-2/2003, IBR-3/ 2011, IBR-4/2017, IBR-6/2020, IBR-7/2020, IBR-8/2020 and IBR-9/2020, it can be said that from the hydrogeological point of view, it represents a somewhat more significant storage space for underground water with millimeter-centimeter cracks dimension within the breccia complex of rocks, which is connected to the main dislocation zone of the "Raduška fault" which is intersected by transverse faults and thus forms a blocky structural-tectonic complex along the course of the Raduška river. About the intensity, verticality and sub-verticality of faulting within the research area of the "Tešanjki kiseljak" source in Gornja Raduša, there is ample evidence in the geomorphology of the terrain, on the measured lines of geophysical reflective seismic profiles, within the swollen local geological columns of structural-research wells, and especially in the core material that is interspersed with cracks of divergent spatial arrangement of mapped slope in core of 30-90° filled or unfilled type.

The slopes of these cracks and crack systems have their surface distribution in the margins of the left and right banks of the Raduška River within the open profiles of the local relief around the production facilities, as well as within the riverbed itself in diabase and metadiabase rock complexes. A special proof of the circulation of natural CO₂ gas in this terrain is the high degree of mylonitization and secondary calcification, i.e. silicification (open cracks and fissures, microcavernous channels) on the largest part of the determined extracted core from exploratory wells, as well as for the first time its clear identification by logging tests in the exploratory column -structural wells IBR-9/2020. Somewhat earlier, gas exhalations with natural CO₂ were registered on the margins of fault blocks, where along tectonically predisposed directions they made their way to the

This, the mineral groundwater aquifer is connected to geologically older rocks (diabases, serpentinites, amphibolites), which are deeply localized within the Gornja Raduša terrain at very different depths within the hitherto swollen geological column. As part of the younger deposits of the Oligomiocene, Plioquaternary and Quaternary (sandstones, gravels, sands, various types of rubble, etc. - rocks of intergranular porosity), and which make up the roof of the older five-described rocks, shallow subsurface releases of groundwater were formed, which do not have significant amounts of water, but they can be enriched with emanations of natural carbon dioxide and thus "acidified" themselves. Younger Povlat sediments with a particularly clayey composition are interesting from the aspect of isolation of the

previously described hydraulic and hydrochemical processes in the source area itself. However, their structural position in the local geomorphology and tectonics itself is not uniform, there are frequent misalignments and reliance on exposed parts of magmatic-metamorphic complexes (diabase, amphibolite, serpentinite, etc.), which should not be ignored either by lateral water communication from Tertiary, Cretaceous and Jurassic sediments.

Replenishment of aquifers (aquifers) of natural mineral waters, which is formed in tectonized diabases and amphibolites, that is, much less often in ultrabasites, is carried out from the water cycle of the precipitation of this climatic area, and the emptying of hydrogeological reservoirs is at local sources and through drainage at well water catchment facilities in the Raduška river basin. enriched with CO₂ gas that ascends the underground water to the surface of the local terrain.

Such specific local hydrodynamics, hydraulics and hydrochemistry of surface and underground waters in the researched area of the source of "Tešanjski kiseljak" was made possible primarily by the existing geomorphology and geology of the terrain in the Raduša fault zone.

The basin type of the narrow alluvial plain of the Raduška River and the heterogeneous lithological composition of rock complexes in a small area with distinct kinematic movement in the vertical column of the younger and older chronostratigraphic range contribute to the specific hydrogeological conditions prevailing in this terrain.

On the other hand, the high artesian pressure of underground mineral waters "Tešanjski kiseljak", in the optimal mode of extraction and exploitation, prevents the mixing of mineral waters with ordinary waters of the alluvium of the Raduška River and surface waters in the catchment area of the surrounding terrain of Gornja Raduša (the latest evidence in the local hydrogeological column of drilled and extracted IEB IBR-8/2018 and IBR-9/2020).

The mentioned hydrogeological conditions, despite the complex factors, contribute to a good extent to the fact that the quality of the mineral waters of the research area "Tešanjski kiseljak" in Gornja Raduša shows constancy and stability over a long period of hydrogeological monitoring and observation (the waters have not changed since the first analyzes from the nineteenth century), and which is the result of their genesis, geological, geotectonic and hydrogeological characteristics of the terrain.

CONCLUSION

The mineral water deposit "Tešanjski kiseljak" belongs to the hydrogeochemical area of mineral and thermomineral waters with CO₂ of the "ophiolitic zone". Cracked rocks of the ophiolite zone have the function of an aquifer of lower water abundance with springs yielding less than 0.1 l/s. The water conductivity of aquifer deposits is higher in fault zones, and mineral springs appear in the zone of the transverse fault along the Raduška river, i.e. its intersection with the longitudinal fault of the northwest-southeast. Mineral water is most likely of atmospheric origin, where by infiltration it penetrates into deeper parts of the terrain and is enriched with CO₂, and by decomposition of rocks it increases mineralization. According to the temperature of the spring water, it can be concluded that the infiltration of atmospheric water and mineral enrichment does not take place at great depths.

Due to the hydraulic pressure and CO₂ content, the mineral water flows out at the Kiseljak spring along the fault of the Raduška River. CO₂ is most likely thermometamorphic, created by the action of SiO₂ on carbonates in deeper parts of the earth's crust, possibly in Middle-Upper Triassic carbonates, which lie deep below the ophiolitic zone in the "ophiolitic mantle" zone. It is not excluded that the formation of CO₂ causes intrusions of young Tertiary magmatism in the deep fault zone extending northwest-southeast Maglaj-Crni vrh and vrh Raduša-Oraš Planje, which should be proven by isotopic tests.

REFERENCE

1. Čičić, S (2002): Geological composition and tectonics of BiH. Monograph, pp. 1-350. Earth Science Institute Sarajevo.
2. Čičić, S. (2003): Geological map of Bosnia and Herzegovina 1:300,000. Institute of Geology, Faculty of Civil Engineering. Sarajevo.
3. Josipović (1971): Mineral, thermal and thermo-mineral waters on the territory of Bosnia and Herzegovina, Geološki glasnik vol. 15, p. 233-275. Sarajevo.
4. Miošić N. (1979): Hydrogeological investigations of mineral waters in the area of Crni Vrh and Raduša - Tešanj, annual report for 1978, Geoinženjering-Sarajevo, Institute for Hydrogeology and Hydrotechnics.

-
5. Pašić-Škrtić. D. (2023): Hydrogeology, University textbook, In Scan d.o.o. Tuzla
 6. Skopljak F. Miošić, N. (1998): Report on the results of previous investigations of mineral waters in the vicinity of Tešnja, Institute of Geology, Sarajevo.
 7. Žigić I., Pašić-Škrtić D. and others (2015): Elaboration on the protection of the Tešanjki kiseljak spring Tešanj Municipality Spreča d.o.o. Tuzla
 8. Elaborate on the execution of exploration and exploitation wells IBR-1 and IBR-2 at the Gornja Raduša site near Tešnj, IBIS-Zavidovići.

HYDROGEOLOGICAL RESEARCH AND TERRAIN CHARACTERIZATION ON A SECTION OF ROAD 2B SARAJEVO-FOČA, AREA OF FBiH

Dinka Pašić-Škripić¹, Adnan Terzić², Amir Jahić³, Meris Hajdarević⁴

ABSTRACT

Roadways are complex construction (line) facilities that have specific characteristics in terms of planning, design and execution of the route. Due to the length of the roads, many characteristics of the terrain such as lithological, hydrogeological, engineering geological and geomorphological change along the route, as a result of which different effects of endodynamic and exodynamic processes and phenomena occur on certain sections. This points to the necessity of an interdisciplinary approach when creating the conceptual and implementation project, in order to choose the optimal solution based on all the influencing parameters.

The route of the road that passes through the Entity of the Federation of Bosnia and Herzegovina, for the most part stretches along the valley of the Željeznica and Dobrinja rivers. The section is located at stations 0+000.00 – 3+250.00, and continues at stations 19+800.00 – 26+100.00, and the total length is 9,550 m'. The area of the studied terrain is located in the zone of the inner Dinarides of Bosnia and Herzegovina, where the pre-mountainous and moderate-continental climate prevails. The elevations of the terrain start at 505 m.a.s.l. in the part of the route near the Stupska petlje loop, and increase to an elevation of 535 m.a.s.l., in the part of Aerodromski settlement, while the second part of the section stac.19+800.00 – 26+100.00 is defined by elevations of 778 m.a.s.l. – 830 m.a.s.l.

Key words: hydrogeological characteristics of the aquifer, route of the Sarajevo-Foča road.

1. HYDROGEOLOGICAL CHARACTERISTICS OF THE TERRAIN IN THE TERRITORY OF THE FEDERATION OF BIH

Formations of Quaternary deposits (al,el-dl), Miocene formations (1M3) and carbonate rocks of the Middle Triassic (T21,2T1) participate in the structure of the terrain. The hydrogeological properties of the isolated units are predisposed by the lithological composition and porosity structure of the rocks that make up them.

On the section in question, the following rock categories were distinguished from the aspect of water permeability:

- permeable rocks i
- impermeable rocks.

Permeable rocks

Permeable rocks are classified based on their porosity structure into:

- permeable rocks of intergranular porosity (well-permeable and poorly water-permeable) i
- permeable rocks of cavernous-fissure porosity.

Well-permeable rocks of intergranular porosity are alluvial deposits (al) formed as a product of deposition of material during the flow of the Željeznica and Dobrinja rivers. They were built predominantly from gravel and sand, and to a lesser extent clayey particles.

¹Ph.D., full professor RGGF, University of Tuzla

²Ba.ing.geol., Sensatec GmbH NL Koln, terzic.adnann@gmail.com

³Ph.D., JU Directorate of Regional Roads of the Tuzla Canton

⁴MSc, "Geoservis" d.o.o. Živinice, meris.hajdarevic11@gmail.com.

The underground water level is free, and depends on the water level of the Željeznica and Dobrinja rivers. From a hydrogeological point of view, they have the function of a near-surface aquifer of greater extent and shallower depth, and relatively fast and seasonally renewable water exchanges. The level of underground water in such an aquifer is free and directly depends on the water levels of the rivers.

Impermeable rocks

Waterproof rocks are presented at the station km. 0+000.00 and stac. km. 26+040.00 Exploratory drilling revealed impermeable formations represented by materials of marly clay and marl, and in the lower horizons by shale, clay and interlayers of sandstone, which represent a hydrogeological insulator through which surface water has no possibility of infiltrating deeper parts. It is important to note that even though shale forms impermeable rocks, they can be poorly impermeable, because it has been established that in some places between the stratification surfaces there is a permeable filling that allows water to flow, and they are also often tectonized and have fissure permeability.

Given that they lie directly below the alluvial and eluvial-deluvial deposits, they represent a podina hydrogeological barrier to the said deposits. There are no aquifers formed in them, but they can filter water, so springs of less abundance appear in places. Waterproof members build the terrain under poorly permeable and well permeable covers. Some exploratory wells did not enter this complex due to the depths of the exploration work planned in the program or deeper marl deposits in the investigated area, but it can be considered that at the defined stations, under the alluvial cover, there is a water-impermeable layer with smaller or larger oscillations in depth.

2. HYDROGEOLOGICAL CHARACTERISTICS OF THE AQUIFER

On the section of the road Sarajevo - Foča (Brod na Drina), at the current level of investigation, the presence of aquifers in permeable and poorly permeable rocks of intergranular permeability was determined.

Alluvial aquifer

It was formed in alluvial sediments developed along the Željeznica river valley. The aquifer is of the exposed type, with a variable thickness of 1.0 - 11.0 meters. The underground water level is free, relatively close to the surface of the terrain and usually conforms to the relief. Aquifers of this type have the characteristic of easy seasonal variability of yield, that is, water abundance. The filtration characteristics of alluvial aquifers are very good.

These sources are fed by the rivers Željeznica and Dobrinja, with which they mostly have a good hydraulic connection, and only seasonally, with a small part from the hinterland, the alluvial aquifer is fed by occasional stream tributaries. The aquifer is recharged by the river Željeznica, with which, in some places, it has a good hydraulic connection. Favorable filtration characteristics and aquifer recharge conditions enable the formation of underground water reserves. It is important to mention that due to the exposure, the relatively small depth to the groundwater level and the hydraulic connection with the Željeznica river, the intergranular porosity aquifer has less favorable conditions for protecting groundwater from pollution.

Eluvial-deluvial aquifers

In addition to the mentioned alluvial aquifer, the presence of near-surface aquifers of greater distribution and shallower depths within the framework of eluvial-deluvial formations was also determined. Like the previous ones, they are characterized by intergranular porosity, and along the route they were noted at the exploration well B-12 and they are open type, of variable thickness.



Figure 1. Lithological profile of well B - 12

The groundwater level is also free and relatively close to the surface. Replenishment is mainly related to the infiltration of precipitation and the melting of the snow cover.

Discharge is in a wider area via a number of smaller occasional sources, or diffuse discharge in the form of pisevins or along the river course of the Željeznica, i.e. alluvial formations. Weak filtration characteristics, low power and recharge conditions of these aquifers of intergranular porosity do not allow the formation of a significant volume of underground water reserves. For these reasons, groundwater is not used for water supply purposes, and protection measures are not foreseen, nor are they applied.

Aquifer of fissure-cavernous porosity

The fissure-cavernous porosity aquifer within the Anisian limestones has a small distribution, and represents a local aquifer within the Triassic impermeable complex. Karstified limestones were found in the exploration well B-12 and BZ-16. At station 19+800 – 24+750, a large number of small streams fed from limestone local aquifers were found.

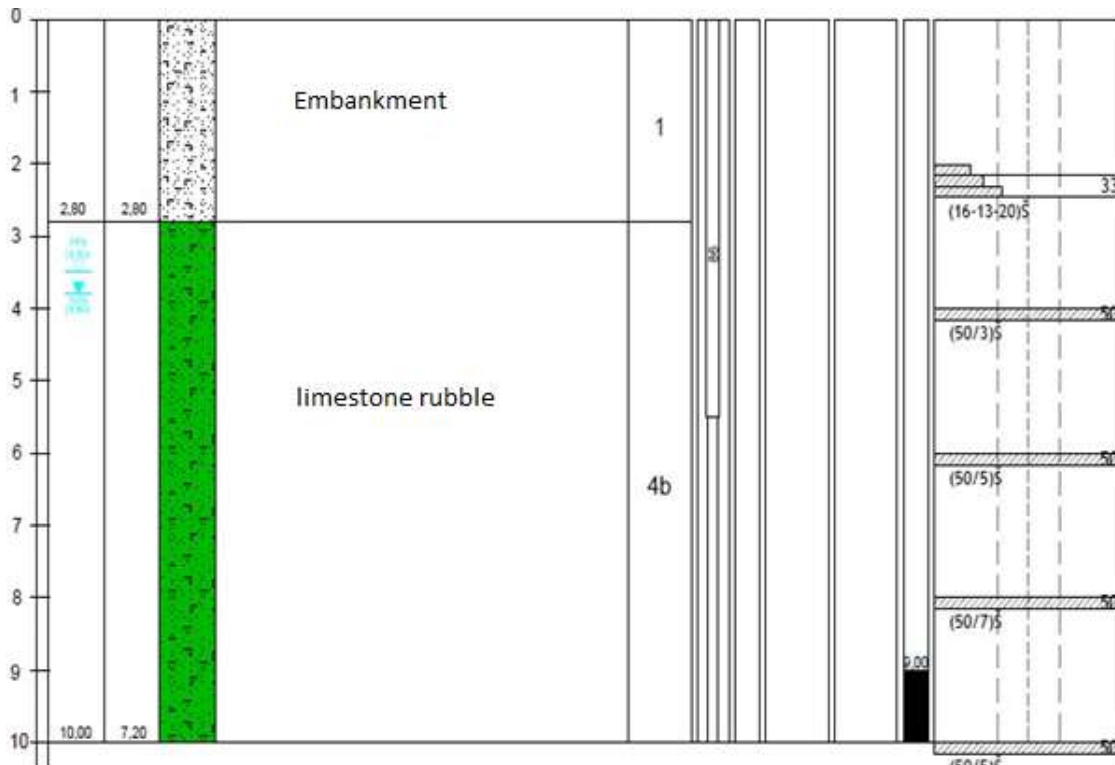

Figure 2. Lithological profile of the BZ - 16 well

3. INSTALLATION OF PIEZOMETER STRUCTURE

In two exploratory wells along the route, piezometer constructions made of plastic 10 bar pipes Ø50, 8mm (2") were installed, which in the zones of groundwater level oscillations were perforated in the necessary lengths. On all piezometers, a concrete protective block was made and a clearly written mark. Tops ("mouth") pipes are protected by a suitable metal screw cap and padlock.



Figure 3. View of the built-in protected piezometer

Measurement of underground water level

During the implementation of investigative works in the field, the occurrence of underground water (PPV) was monitored, which was noted in 15 investigative wells, as well as the level of underground water

measured 24 hours after the end of each investigative work. Since the Stup - Foča section stretches through the alluvial sediments of the Željeznica River, in a large number of exploratory wells, the installation of a column was used, after the extraction of which there was a collapse in the gravel and sandy horizons.

In addition to table 1, which shows the occurrence of underground water and the level of underground water that was ascertained during exploratory drilling, piezometers were installed in two exploratory wells, which were used to measure the oscillation of the underground water level, in the period after drilling.

Table 1. Presentation of the well mark and the level of underground water, during several months of measurement

Well mark	Depth	Groundwater level	Occurrence of underground water (PPV)	Well mark	Depth	Underground water level	Underground water occurrence (PPV)
B-1	10,00	-	-	BZ-4	8,00	-4,20	-3,10
B-2	10,00	-7,50	- 7,50	BZ-16	10,00	3,80	3,50
B-11	7,00	-	-	BP-1	15,00	-	-
B-12	15,00	-	-	BP-2	20,00	-	-
B-13	7,00	-2,10	-2,10	BM-1	10,00	zarušeno	-3,70
B-14	7,00	-	-	BM-2	15,00	-3,50	-3,00
B-15	7,00	-	-	BM-3	16,70	-4,10	-5,00
B-17	7,00	-	-	BM-4	10,00	zarušeno	-2,40
B-18	7,00	-	-	BM-6	15,00	zarušeno	-3,70
BZ-1	8,00	zarušeno	- 4,30	BM-8	10,00	zarušeno	-4,30
BZ-2	8,00	- 3,00	- 3,00	BM-30	20,00	1,90	1,90
BZ-3	8,00	-4,50	-4,00	BM-31	20,00	1,90	1,90

Bušotina/dubina (m)	Datum i NPV (m)				
	21.09.2022	19.10.2020	26.11.2020	25.12.2020	25.01.2021
BM-3 (16,70)	-4,10	-4,50	-4,60	-4,40	-3,80
BM-30 (20,00)	-	-	-1,90	-1,60	-1,50

4. ASSESSMENT OF THE RISK OF GROUND AND SURFACE WATER POLLUTION

Taking into account the hydrogeological categorization of rocks and their function, two categories of terrain can be distinguished in relation to the assessment of the risk of groundwater and surface water pollution, namely:

- low risk zone i
- high risk zone.

Low risk zone

The zone of low risk of underground and surface water pollution is separated in the parts where the route stretches along the terrain built of impermeable and poorly permeable dusty - sandy clays of eluvial-deluvial cover. It is separated between stations:

- station km 19+800 – 20+390,
- station km. 21+850-22+200,
- station km 23+500-23+670,
- station km 25+290-25+550.

It is estimated that a milder protection regime should be applied in this zone, with the recommendation that absorbent devices for drainage of water from the road, masts and the like, be disposed at optimal positions along the route.

High risk zone

The zone of high risk of underground and surface water pollution is separated in the terrain built of water-permeable rocks of intergranular porosity, that is, in alluvial deposits, and of well-permeable rocks of fissure-cavernous porosity. It is separated between stations:

- station km 0+000.00 – 3+250.00,
- station km 20+390.00 – 21+850.00,
- station km 22+200.00-23+500.00,
- station km 23+670.00-25+290.00,
- station km 25+550.00-26+100.00.

The rocks that make up the terrain in this zone have the hydrogeological function of aquifers of greater distribution, and are registered water bodies used for water supply.

For these reasons, protective measures appropriate to the high risk of pollution must be recommended. In any case, the solutions must be based on the conditions to accept all rainwater from the surface of the road and the connection loop facility, as well as seepage-drainage water from the trunk of the road that may be polluted by oil derivatives, as well as during incident pollution, and must be removed through a watertight sewer outside the source zone and treated with appropriate purification devices before entering the recipient. Also on this section, in addition to the hydrogeological characteristics, unwanted effects and risks of groundwater and surface water pollution that may arise as a result of incident situations, i.e. damage to passenger vehicles, or vehicles transporting liquid and solid materials must be anticipated. The risk of groundwater and surface water pollution is not the same, and special attention should be paid to sensitive and critical moves, regardless of which risk zone they are in.

Within the isolated risk zones of groundwater and surface water pollution, the following protective measures can generally be proposed:

- in the high-risk zone, engineering-geological rigorous protection measures and conditions for water purification from the well are proposed with the application of project solutions that include a closed drainage system, with purification to the prescribed quality level and complete drainage;
- in the low risk zone, milder protection measures with the so-called open drainage system, whereby mechanical water purification is not excluded. This does not imply drainage from the highway without control, and it is necessary to foresee technical solutions for additional water purification, especially on critical sections or sections that are determined to be places of potentially higher risk.

CONCLUSION

On the basis of extensive hydrogeological and other works carried out in the zone of the route of the planned road in the territory of FBiH, especially the data of groundwater level measurements during the implementation of exploratory drilling, starting from March to July 2022, a series of very significant analyzes were carried out on the basis of which concrete conclusions.

In the area of the Bogatići tunnel - which is located between stations 0+797.00 – 0+896.50 in a length of 99.50 meters, the basic hydrogeological conditions of its construction were analyzed based on the data of the hydrogeological characteristics of the wider area. It was assessed that groundwater is not a significant influencing factor on the engineering-geological conditions of construction. In the excavation of the Bogatići tunnel, in the limestone, maximum short-term inflows of water up to about 1l/s are expected during wet periods. The conditions for foundation of bridges and overpasses, depending on the adopted method of foundation of pillars, are different. In the case of foundations of pillars by excavation in alluvial deposits, inflow of water from rivers is expected. The maximum inflow into the foundation pit can be 10-20 l/s depending on the water level of the rivers in the section, the dimensions of the excavation, the distance from the river, etc. A significant influence of underground and surface water on the conditions of the foundation of the pillars is not expected, especially in the dry period.

In the open part of the route, the influence of underground water on the excavation of the foundation of the embankment practically does not exist, which is evident when looking at the hydrogeological section of the terrain. Groundwater was registered in only a few wells during drilling. Difficult construction conditions are expected in the zone of occasional flows that plunge along the route of the current road, that is, if excavations are made to enter the karst channels during periods of heavy and prolonged rainfall.

From the above, it can be concluded that the hydrogeological issues, that is, the conditions for the construction of the road route are not unfavorable from the aspect of the negative influence of groundwater.

LITERATURE

1. Balta, V., Hydrogeological characteristics of the area as a factor in defining risk zones on the "Vc corridor" in terms of environmental protection, doctoral dissertation, 2015.
2. Čičić, S., Geological composition and tectonics of Bosnia and Herzegovina, pp. 1-350. Earth Science Institute. Sarajevo, 2002.
3. Hrvatović, H., Geological guidebook through Bosnia and Herzegovina, Federal Institute of Geology, Sarajevo, 2006.
4. Pašić-Škripić D., Injection and consolidation of soil and rocks, University of Tuzla, 2022.
5. Sijerčić, I., Engineering Geodynamics, University of Tuzla, In Scan, 2012.
6. Skopljak, F., Hydrogeology, field research and tests, Sarajevo, 2022.
8. Škripić, N., Engineering geology (selected chapters), Polytechnic Faculty of the University of Zenica, 2014.
9. Terzić, A., "Hydrogeological conditions in the zone of the road route on section 2B Sarajevo-Foča", master's thesis, RGGF, University of Tuzla, 2023.
9. Žigić, I., Hydrogeological research, University of Tuzla, 2004.

ANALYSIS AND REMEDIATION OF ENDOGENOUS FIRE AT LONGWALL TOTAL COAL THICKNESS MINING OF THE MAIN COAL SEAM IN RASPOTOČJE MINE OF ZENICA BROWN COAL MINES

Jelena Marković¹, Refik Kurbašić², Zvezdan Karadžin³, Edisa Nukić⁴

ABSTRACT

Mining of the thick coal layers that include roof caving operation can result in residual coal quantities in the gob as a potential threat causing occurrence of spontaneous oxidation process, smoldering, and endogenous mine fire that can affect the safety and regular mine operations.

Endogenous fire occurrences in Zenica coal mines are directly linked to complex natural conditions reflecting in complex geological conditions, great depth of mining, high methane content in coal seams, and tendency of coal to spontaneous oxidation process.

The subject of the paper is the analysis of endogenous fire suppression method applied in conditions of complete coal thickness longwall mining in Raspotočje mine, that has been rehabilitated upon the endogenous fire and then reactivated. The following methods were used in fire fighting: passive fire fighting methods (sealing of the area affected by the fire), active method (injection of electrofilter ash) and ventilation methods. Furthermore additional data (position of gob area and sealing objects, air flow regulators, routes of possible air migration, suggested technical solutions, etc) were added in the linear and canonic schemes for the purpose of defining efficient solutions for fire fighting.

Key words: endogenous fire, longwall mining, advancing mining, fire fighting.

1. INTRODUCTION

Mining method applied in Zenica coal mines include caving of roof into the mined out area, without stowing-filling of voids created. Consequences of such a mining method result in increased flow (migration) of air through the gob of the longwall face, that is very dangerous from the point of fire hazards [2] [4]. These air migrations occur in the peripheral zones of mined out areas toward the safety pillar and unmined parts (along the workings and starting room- start line of the longwall face), and the parts immediately behind the longwall face, where a certain phase of final consolidation is taking place (roof caving, crushing of the roof, roof breakage, elastic deformation of the roof) [1] [5].

Volume and quantities of migrating air depend of inner and external difference in pressure potentials, resistance along the migration routes, area of the mining panel, mining web height, depth of workings, geomechanical rock properties in lithostratigraphical column and ground tectonics in the mining zone. In the working panels when mining was conducted in roof plates of the main coal seam (GUS) a contact was made with the gob areas of the previous overlaying mining panels, resulting in air migrations, that were very dangerous from the point of possible fire occurrences [2] [3].

¹University of Tuzla, Faculty of Mining, Geology and Civil Engineering, jelena.markovic@untz.ba

² Full professor, Association-FUZIP-e, Sarajevo, Bosnia and Herzegovina

³Associate professor, University of Tuzla, Faculty of Mining, Geology and Civil Engineering, zvezdan.karadzjin@untz.ba

⁴Associate professor, University of Tuzla, Faculty of Mining, Geology and Civil Engineering, edisa.nukic@untz.ba

Mining in two working panels in the fourth tectonic block of the Eastern part of VII mine terrace, was conducted in the period October 1999-May 2005 using longwall-sublevel mining method. Two endogenous fires occurred in that period in the gob area of the longwall face, one when the advancing, and one when the retreating mining system was applied. This paper deals with the analysis of the endogenous fire in panel where advancing mining system was applied.

2. WORKING CONDITIONS IN MINING PANEL

Complete coal thickness mining of the Main coal seam (GUS) in two working panels in the fourth tectonic block of the VII mine terrace, was performed using longwall-sublevel mining method. The coal from the roof part was caved down, without blasting, initiated by collapsing of the coal console when the self-powered hydraulic support was moving forward [8]. Applied method of total coal thickness mining is shown in Figure 1.

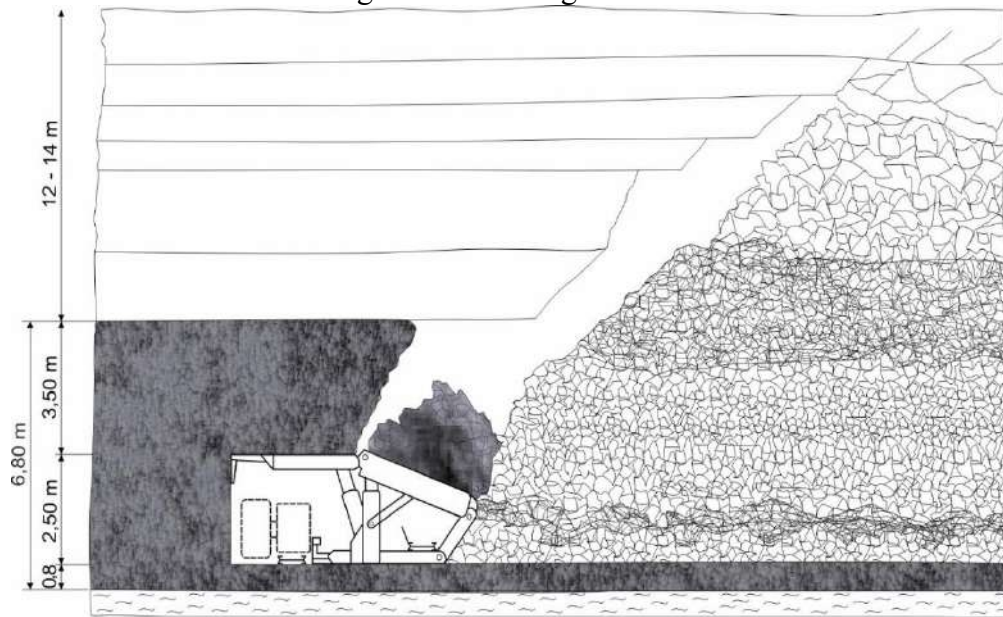

Figure 1. Total coal thickness mining of the Main coal seam in Raspočje mine using „Sublevel“ method with Dowty 4000 self-powered hydraulic support [8]

Main parameters of the working method geometry [8]:

- length of the longwall face..... 75,0 m,
- total web height.....5.5-6.0 m,
- level part.....1.8-2.5 m,
- roof part.....3.5-4.2 m,
- protection plate in the floor.....0.5-1.0 m,
- productivity.....aprox. 8.0 t/m² or 550.0 t/m' of face advance.

Yield/recovery of the total Main coal seam thickness was approx 80 %. Losses of coal (aprox. 20 %) account for the protection coal plates left in the floor part toward the marly-clay floor, and losses of coal at the opening for roof coal drawing at the final prop of the self-powered hydraulic support (SHS), that at the 1 m from the floor coal plate create a plane of crushed coal in the caved material (in the gob area of the longwall workings). These losses, giving the propensity of main coal seam to spontaneous oxidation, present a constant threat for occurrences of endogenous fire in the gob area of the longwall working panels. The special danger for occurrences of primary fire ignition spots, present the crushed coal fines that remain in the floor plate, upon the passage of the longwall face. Removal of this coal in the space between the conveyors is difficult due to the closed construction of the support units.

Ventilation

Ventilation system of the mine active part (TB-IV, VII terrace of the Eastern part of the mine), is a very complex system, with a gob of the working panel G-VII-i-4/1 placed with the parallel, whose lateral present ventilation incline VU-114 from one side, and total ventilation system of the active workings, on

the other side. Ventilation corridor for the next panel VX-207/1 that is currently being prepared, present a diagonal between the laterals and closes the gob from the lower (eastern) side.

Ventilation air for the active workings is introduced by the main ventilation network through the short eastern connecting drift (KIP) to the entrance of TB-IV, where the lateral lines of the paralel system were created, while one part of the intake air was separated into the mine return air via short connection across the corridor to K 4,0 m. The first part of the lateral line VU-114 served to ventilate TS „F“, while the other part of the lateral line served to take out the return air from the workings for the workings on a new part of VH-207/1. The other lateral line serves for ventilating active workings in block TB-IV, chamber workings and development workings for chamber panels, longwall face and workings on drivage of ventilation corridor VH-207/1. Figure 2 shows a linear ventilation scheme of VII terrace of the eastern part of the mine (Block TB-IV) before closure of longwall workings required to supress the endogenous fire.

Sealing of gob area

Sealing of the longwall workings gob area was conducted using 4-12 m long so called mud plugs (hydraulic stowing) made of fine electrofilter ash. Sealing objects that close the gob area in the western side from the ventilation incline VU-114 (MČ 69 and 70) were constructed in length of 10 meters in the floor part of the Main coal seam (GUS). Gob sealing in the lower (southern) side from the ventilation corridor VH-207/1 were carried out with 4-5 m long mud plugs, no 208/1, 208/2, 208/3 and 208/4.

Mud plugs no.208/5 and 208/6 that closed the gob area from the transport corridor TH-208, that were additionally reinforced with barriers covered with cement mortar, were constructed in the lower part of the connecting rise VU-208/5 and VU 208/6, at distance of 5-6 m from the transport corridor TH-208. Sealing in the upper (northern) side from the ventilation corridor VH-205 was carried out using 5-12 m long mud plugs mainly constructed in the roof layers of GUS (corridor drifted through the fault zone) marked as MČ: 205/1, 205/2, „05/3, 205/4, 205/5, 205/6 and 205/7.

Longwall face advance

DAWTY 4L-4000 kN self-powered hydraulic support with accessory equipment, was installed in working panel G-VII-i-4/1 in October 1999. Longwall face advance rate was aprox 21 m/month in two months period. In the year 2000 the average advance rate was 23.5 m/month. Advanced rate slowed down in 2001 to 18.75 on average. Sudden slow down in advance occured in the second half of the year when the advance rate was 15.8 m/month. Advance longwall face rate in the nine months of 2002 was 13.11 m/month on average.

Advance of longwall face since the occurence of spontaneous fire on October 8 2002 until December 31 2002 was 12 meters in total.

3. ENDOGENOUS FIRES OCCURING AT THE ADVANCING SYSTEM OF TOTAL COAL THICKNESS MINING

3.1. Analysis of endogenous fire and remediation procedures - october 2002

First signs of endogenous fire occured on October 8, 2002, when the CO₂ concentration of 40 ppm was measured at the exit from the longwall face. Regardless of the effort to prevent oxidation process, it still progressed, resulting in CO₂ concentration of 135 ppm at the exit from the longwall face on October 13, 2002. The longwall face was ventilated with 4 m³/s of air, absolute inflow of CO at the exit from the face increased to over 50 dm³/min. The decision on closure of longwall face was made that day in order to prevent the endogenous fire. Incomplete closure with barrages in transport and ventilation corridor was finished on October 15, 2002. Barrages were constructed of concrete blocks with 0.8 x 0.6 m opennings on barrages that had to be closed simultaneously. Opennings served for air intake od aprox 1.3 m³/s. The regular recording of the gas -ventilation parameters was conducted upon the closure, to carry out analyses regarding fire status and to undertake required remediation measures .

Control of gob sealing objects OP G-VII and 4/1 showed that there was an air contact between the working zone 207/1A (route between connecting rises VU-208/5 and VU 208/6) and the gob area. Increased CH₄ and CO₂ concentrations were detected at the workings, along with 40 ppm CO concentration upon the temporary closure of the longwall face. Therefore the operations at the workings were ceased and separate fan was shut down, while in the connecting rise VU-208/5 a ventilation concrete blocks barrage was constructed at the distance of 5 m from transport corridor.

Another barrage was constructed for closure of connecting rise VU -208/6 , because it proved that the mud plug 208/6 was not properly filled with sealing material. These barrages were constructed on October 15, 2002. Figure 3 shows a linear ventilation scheme of the VII terrace of the Eastern part (Block TB-IV) in Raspotočje mine upon closure of connecting rises (208/5 and 208/6) and the longwall face.

During the construction of sealing objects, a detailed inspections of sealing objects of the active mine part were conducted, and the following conclusions were drawn:

- Mud plugs that sealed the gob area from the ventilation rise VU-114 (MČ 70 and MČ 69), ventilation corridor VH -205 (MČ from 205/1 to 205/7) and ventilation corridor - 207/1 (MČ from 208/1 to 208/4) were in proper condition and there was no air contact with the gob area.
- Fire gasses (characteristic smell and measured concentration of CO up to 60 ppm) occured in the upper part of the longwall face
- Temperature at the exit from longwall face was reduced by 2°C in relation to temperature measured before closure (from 28°C to 26°C)
- Temperature at the top of the longwall face was reduced by 2°C (from 30°C to 28°C)
- Absolute inflow of carbon monoxide (CO) was reduced to 15 dm³/min
- Gasses concentrations measured at the top of longwall face were: CH₄= 1,50 %, CO₂= 1,0 % and CO = 65 ppm.
- Temperatures measured in OP-GVII-i-IV/1 varied from 19-20°C at the entrance to 25-26 °C at the exit from longwall face.

Fast stabilisation of conditions at longwall face that followed upon the construction of sealing barriers enabled restart of mining activities at longwall face, with supplied air volume of 2.80 m³/s, without further occurrence of CO up to beginning of December 2002. Figure 4 shows diagram of depression changes at mud plugs that seal the gob area of the working panel OP G VII-i/1, and Figure 5 shows diagram of temperature changes in front of the mud plugs that seal the working field OP G VII-i/1 for the period: 07.10.–24.10. 2002.

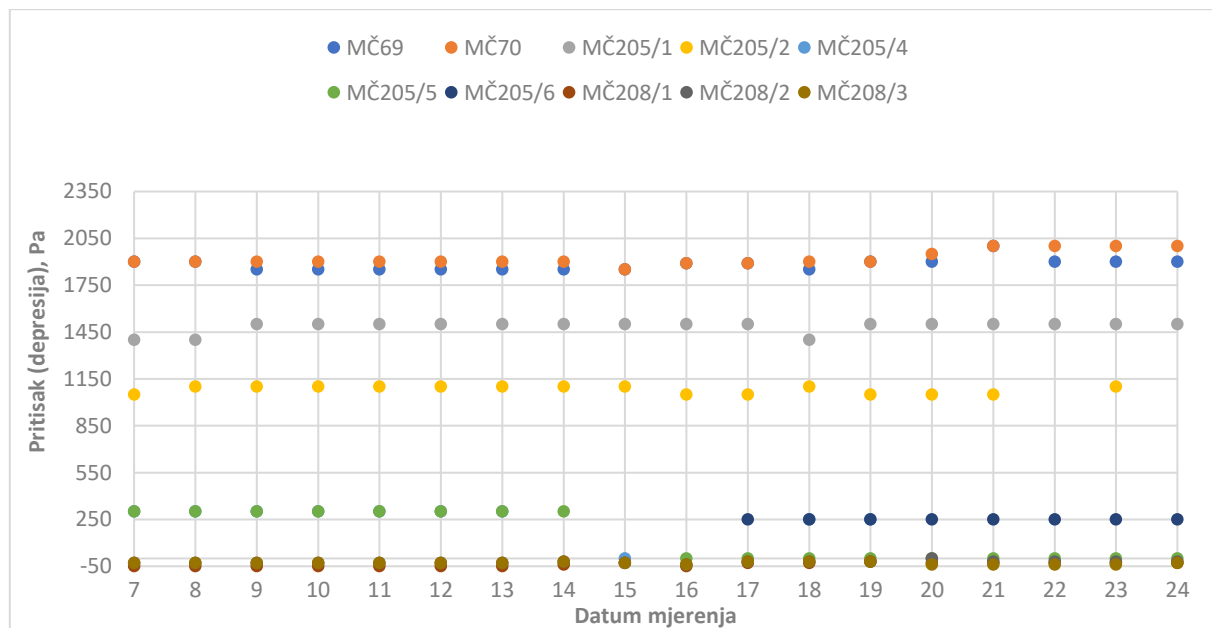

Figure 4. Diagram of depression changes at mud plugs that seal the gob area of the working panel OP G VII-i/1for the period: 07.10.–24.10. 2002.

Pressure values measured at the sealing barriers show the following:

- In ventilation corridor VH-205 (lateral line of the parallel), that served to take out return air, consumption of fan depression was extremely high: from MČ205/1 with pressure of approx. 1500 Pa to MČ 205/6, where it amounted up to 250 Pa (difference of 1250 Pa).
- In corridor 207/1 (diagonal), wall was under depression of -50 Pa at MČ 208/1 to - 20 Pa at MČ 208/3. Utilization of main fan depression at that route was insignificant since the working operations in that branch were ventilated using auxiliary (separate) fan.
- Measured pressure values at the walls of ventilation rise VU 114 (lateral line of the parallel) were extremely high: 1900 Pa at MČ 69 and 2000 Pa at MČ 70, as a consequence of installed flow regulator, under the location MČ 69 and 70, toward the intake air flow.
- Due to the big difference in pressure between the rooms from which the gob area was sealed, and due to big difference in pressures between these rooms and air current for ventilation of longwall face (open contact with the gob area), in the case of possible deterioration of sealing properties at mud plugs (MČ) or breakage of pillars between rooms and gob area, various combinations of air inflow into the gob area were feasible. Any kind of air inflow into the gob inevitably results in occurrences of spontaneous oxidation and endogenous fire in the gob area (peripheral part of the gob area toward the fresh air flow) [4].

Minor oscillations in pressure took place during the spontaneous burning process, dominantly as a result of gob area heating, and less because of changes in outside atmospheric pressure, that was quite stable in the observed period. These changes were mostly emphasized at the wall of room 207/1, where reduction and equalization of pressures at the walls along the entire route took place between 17th and 24th of October, 2002.

Changes in air flow in the branch for ventilation of longwall face, did not result in significant pressure changes at sealing objects, that can be a result of a complex ventilation system of working block TB-IV. Pressure decrease in branch for ventilation of longwall face (ŠČ) was not high, giving the short distance, adequate cross section of the route and relatively small quantity of air flow, therefore the changes in ventilation regime of longwall face did not significantly affect the potentials relations. However, these potentials changes, regardless how small they were, had a positive influence on creating favourable gas relations in gob area and creation of conditions, along with other measures applied, for proper suppression of endogenous fire.

During the observed period the outside temperatures ranged from 4 to 15 degrees C. Temperatures at the entry ranged from 19 to 20 degrees, and 22-23 degrees at the exit from the longwall face.

Temperatures at sealing objects for the gob area from the ventilation corridor VH-205 (MČ 205/1, 205/2, 205/3, 205/4, 205/5 i 205/6), did not change significantly, and the total temperature increase was max 2 degrees in the observed period.

It can be explained by the position of sealing objects, that were 8-10 m lower than gob area (VH-ŠČ) and driven in the surrounding rocks (fault zone between TB-III and TB-IV). Similar alteration in temperature occurred at the walls that close gob area of longwall face from the ventilation rise VU-114 (MČ 69 and 70). Those walls were the most distant from the assumed place of oxidation process, thus small temperature changes can be explained on those objects.

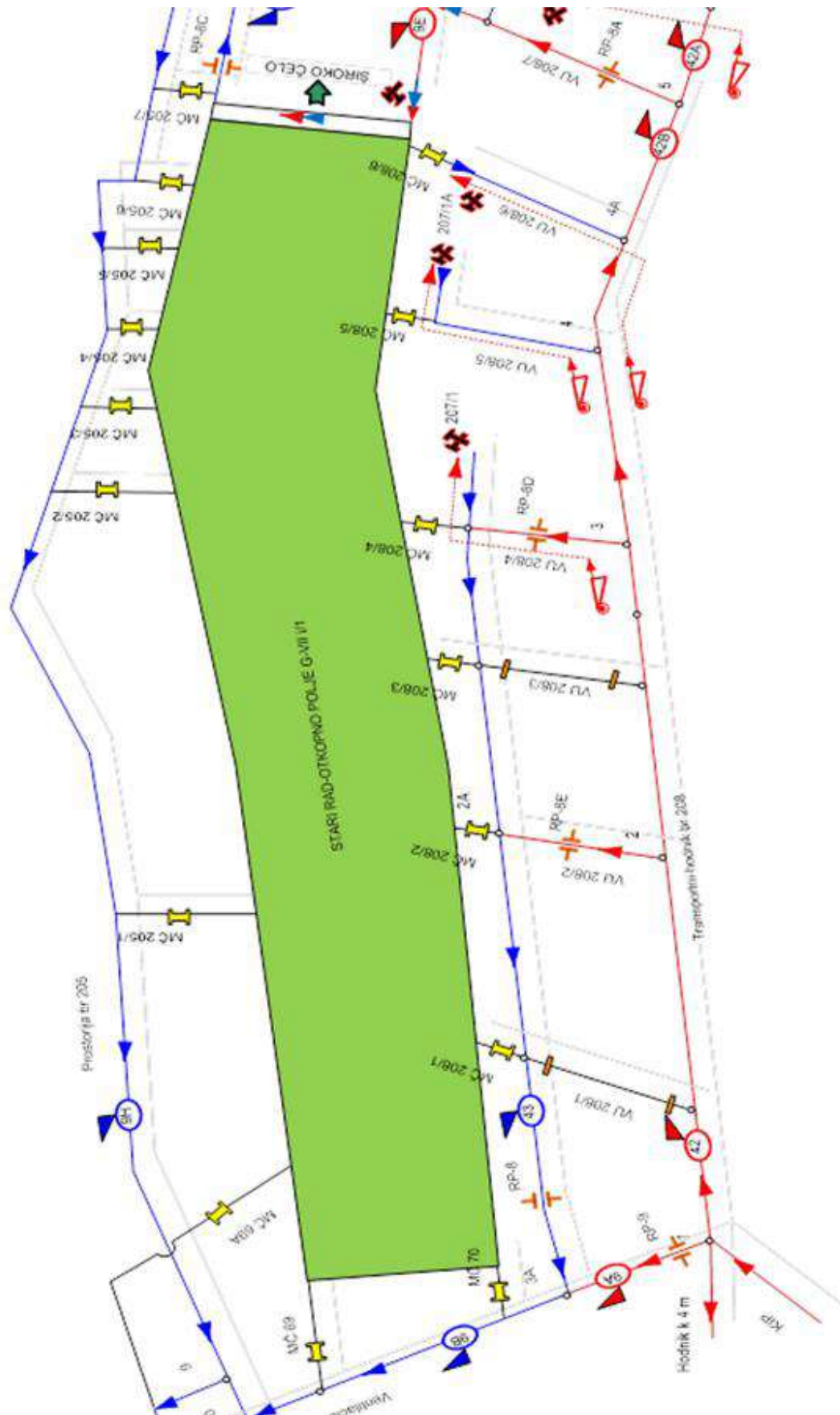

Figure 2. Linear ventilation scheme – VII Terrace , Eastern part (Block TB-IV) Raspotočje mine, before closure of the longwall face, Status: October 2002 [1]

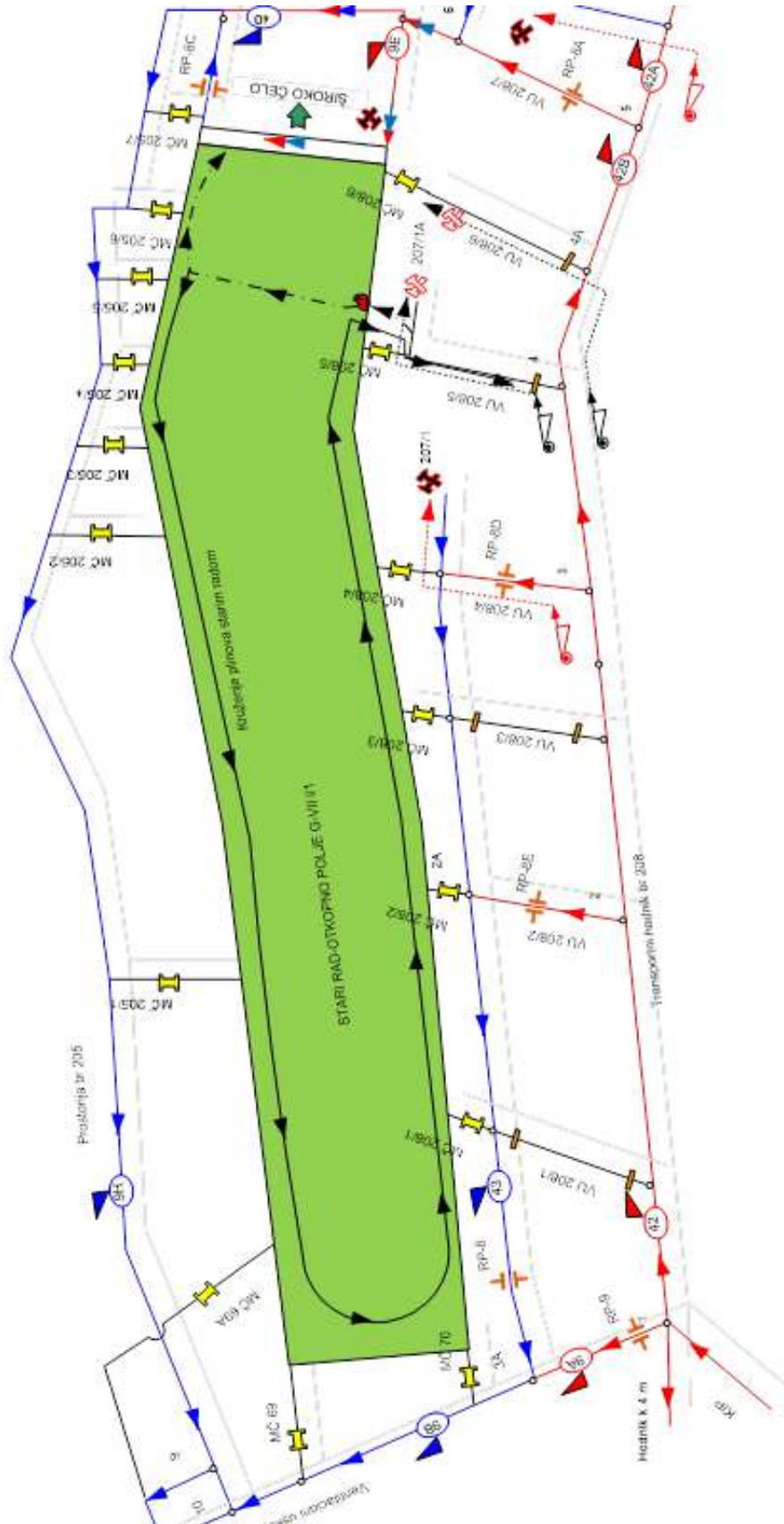

Figure 3. Linear ventilation scheme – VII Terrace , Eastern part (Block TB-IV) Raspočje mine, upon closure of the longwall face and connecting rises (208/5 and 208/6) (Circulation of heated gasses in gob area OP G-VIII i/1, suppression of methane from gob area and accumulation in ventilation rise VU 208/5) [1]

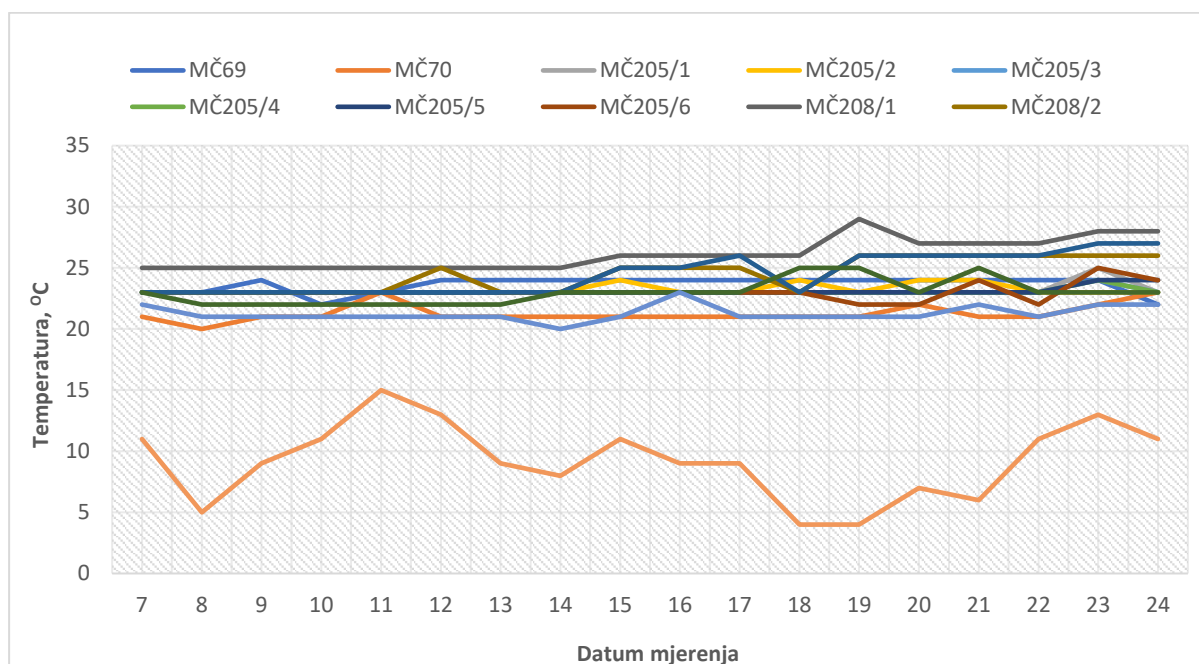

Figure 5. Diagram of temperature changes in front of mud plugs that seal working panel OP G VII-i/1 Period: 07.10.-24.10. 2002.

Temperature changes at mud plugs that seal the gob from the ventilation corridor VH-207/1 during the observed period were the highest. Total increase in temperature at MČ (except of MČ 208/4) were 4 °C. This can be explained by circulation of fire gasses through the gob area that was conditioned by temperature uplift and the shape of mined out gob area of ŠČ. Mining panel G VII-i-4/1 dips toward the longwall face advance direction, slightly diagonal on strike of Main coal seam (GUS) - strike of GUS is northwest-southeast, with longwall face advance toward southeast. Dip angle of the mining panel is 11-15°, with average altitude difference between working corridors of 16 m.

The crucial role for creation of such gas movement in the gob area of longwall face, apart from the shape of mined out area, had some other influential factors such as: assumed position of spontaneous oxidation, intensity and development of endogenous fire, longwall face ventilation regime, with a negligible influence of main fan depression on longwall face (gob of the longwall workings). Temperatures at objects that seal the gob area from the transport corridor TH-208, did not change significantly, because of auxiliary barriers that were put to reinforce the previously installed mud plug (MČ).

Gas control of gob status behind the sealing objects was performed using chemical analysis method. It was detected that changes in gas conditions in front of the sealing objects were insignificant (normal). The determined gas conditions behind the sealing objects indicate following:

- a) At the walls that seal the gob from ventilation rise VU-114 (walls no 69. and 70.) it was observed that gob was in the phase of consolidation. Oxygen content was under 12 %, carbon dioxide content over 6.5 %, and methane content aprox. 1.0 %. Presence of carbon monoxide was not detected by chemical analysis.
- b) At the walls that seal the gob from ventilation corridor VH-205 the following changes were noticed:
 - At the wall 205/1, that is the most distant from assumed spontaneous oxidation, no changes were detected. The gob area was consolidated, and no occurrence of CO were registered.
 - At the wall 205/3, an increased presence of oxygen was registered on October 9, 2002, along with 330 ppm of CO.

- The most significant changes of gas conditions at the beginning of spontaneous oxidation were registered on the wall no: 205/4, 205/5, 205/6, with content of CO ranging from 100 to 3500 PPM, and then significant changes occurred only on the wall no 205/6.
 - Significantly low content of methane on these walls (under 1.0 %) can be explained by movement of methane due to heat depression of accumulated fire gasses, that were moving toward the upper parts of gob area and it pushed the cooler methane into lower parts of gob area (circulation of fire gasses along gob area, suppression of methane from the gob area into the room 208/5).
 - As for the wall 205/6, content of CO on October 21, 2002, was increasing constantly, and then it started decreasing with simultaneous expected increase in CO₂ and decrease in O₂ content. Such behaviour of fire gasses behind the wall was expected as a direct consequence of measures undertaken on remediation of endogenous fire. Similar changes of gas status were registered at the top of longwall face (diffusely ventilated part of the longwall face).
- c) Upon the intensification of endogenous fire walls that seal the gob from the transport corridor TH-208 were additionally reinforced by concrete block barriers due to assumption that the air contact with gob of longwall face is enabled through these walls. The space behind the barrier 208/5 (connecting rise VU-208/5 and driven route of ventilation corridor VH-207/1A), of total volume of approx 1000 m³, was gassed soon upon the closure, with enormous methane content detected of over 50.0 %. Upon the closure of the rise, occurrence of CO in traces of up to 5 ppm were registered by chemical analyses, while a concentration of CO of 40 ppm was registered before closure using portable measuring instrument. Behind the barrier no 208/6, that was installed simultaneously with barrier no 208/5, that seal ventilation rise VU-208/6, with total volume of approx 600 m³, the registered content of methane was up to 3.50 %.
- Such a drastic difference in methane content behind the two adjacent walls can be explained by the following hypotheses:
- Space behind the barrier is filled with gasses produced by exhalation from crushed coal seam due to crushing of the safety pillar, and trapped methane source that was opened by advance of the ventilation corridor VH-207/1,
 - Behind those two walls was a space in which the endogenous fire occurred, and methane was accumulated in ventilation rise 208/5 due to described circulation of fire gasses in the gob area and crushing of the safety pillar between the gob and driven part of the ventilation rise VU-207/1, situated in the roof plate of the Main coal seam. This occurred partly because of the condition of the walls in ventilation system, that was mainly close to balanced values (depression on wall was 0 Pa).
 - However, the hypothesis concerning the existence of connection between VH-207/1A and the gob area OP G-VII-i-4/1, and hypothesis on circulation of gasses in the gob area OP G-VII-i/1, suppression of methane from the gob area and its accumulation in VU 208/5, were confirmed with this analysis. See Figure 3.
- d) Analyses of recording taken behind the walls that seal the gob from the room 207/1 (walls no 208/1, 208/2 and 208/3) were mostly dependant on sampling model (experience of the sampler) [7], since those walls were under a small depression (retracting) during the observed period.
- Recording of gasses conditions behind and gas-ventilation parameters in front of the walls deny possibility of any kind of air flow through the gob area toward and away from the objects that seal the gob area from the rooms VH-205 and VU-114, and walls that seal the gob from the room VH-207/1 (walls no.208/1, 208/2 and 208/3). Only potentially suspicious were the walls no 208/5 and 208/6.
- e) The exact location of spontaneous oxidation was not reliably determined but analysis of influential factors lead to assumption that the oxidation process occurred in the safety pillar, at the edge of gob area toward VH-207/1A, between walls no 208/5 and 208/6, see Figure 3.

3.2 Analysis of reactivated endogenous fire - December, 2002.

Reactivation of endogenous fire occurred in the beginning of December due to a wrong decision brought regarding continuation of activities on drive of remaining part of ventilation corridor VH-207/1, i.e. opening and degassing of VU-208/5 and VU-208/6 [1]. Upon degassing of connecting rise, drive of a part of the ventilation corridor VH-207/1A between the rise 208/5 and 208/6 and assembly rise (MU) and TH-208 was started.

Opening of connecting rises resulted in intense endogenous fire with CO concentration reaching 1000 ppm in five days. Therefore the further longwall face operations were ceased on December 5, 2002,

and then it was closed again. Active measures were carried out to prevent quick intensification of endogenous fire (Slurrying, splashing and soaking of the gob area) but its suppression was not feasible. Analysis of operational data (recording of gas status and temperature along the longwall face, and „in situ“ data on occurrences of condensation on self powered hydraulic support (SHP) proved that fire was getting closer to the lower part of the longwall face. Therefore a fanlike disposition of drillholes was applied and they were drilled from the assembly rise (MU), with the aim of drillholes reaching the highest point of caving arch of the immediate roof, while in the line of coal seam they created a hypotenuse of a triangle: longwall face line TH 207- drillhole line penetration into the assumed spontaneous oxidation zone. The intention was to suppress the endogenous fire in total through slurrying from drillholes and splashing from the longwall face area in that triangle, and that was fully achieved.

A filtration barrier was constructed for that purpose in transport corridor TH-207, behind which a mud plug was created in the floor of the room, in length of 40.0 m, that slurried and suppressed the fire in fine coal along the transport corridor, and prevented air flow into the oxidation process. Simultaneously the gob area was splashed with solution of electro filter ash from the active part of longwall face, especially in its lower part.

Active remediation measures were followed by ventilation measures. Driving of the assembly rise (route 4-7A) resulted in significant decrease of resistance in TB-IV, especially in the zone of active workings (chamber workings and longwall face). Route 7A-7-8, was used as an extinguishing branch. The room was generally cleared of piled up coal, while equipment and auxiliary materials were removed in order to decrease resistance along the route (decrease in difference of potentials along the route). Thus the potentials at the entrance and the exit from the longwall face were equalized (usage of depression at the route 7A-7-8 was reduced to minimum). A regulator (RP-8B) was installed in the assembly rise to regulate air flow to 5.0 m³/s. Simultaneously a combined ventilation system was applied at the longwall face, using separate fan. Total air flow for ventilation of longwall face was 3.0 m³/s, consisting of air flow driven by separate fan of 3 m³/s, while approx 0,7 m³/s were driven by main fan. Separate fan was installed in the transport corridor TH-207, at the entrance into the longwall face, with the end of the pipeline for separate ventilation on the 23rd unit of the self-powered hydraulic support SHP (43 m of the longwall face). Regulation of the required air flow was carried out by damping at the end of the pipeline, while regulation of the total air quantities for longwall face was made using air flow regulator 8C.

In that way the influence of the main fan on the gob of the longwall face was reduced. That resulted in reduction of migration of air through the gob area of the longwall face, reduction of fire gasses circulation into the working space of longwall face, and the line of consolidated gob get closer to longwall face line, and along with all other measures undertaken, it resulted in complete suppression of oxidation process, by the midst of January 2003. Canonic ventilation scheme of the Eastern part of Raspočje mine (TB-IV) upon reclosure of connecting rises VU-208/5 and VU 208/6 and assembly rise (MU) is shown in Figure 6. Figure 7 shows a diagram of fire coefficient based on occurrence of CO, on the exit from longwall face, for the period October 8 to December 31, 2002. During that period occurrence of endogenous fire took place, then closure of the longwall face, followed by its opening, reoxidation process and reclosure of longwall face. Comparative diagram of fire coefficients: G, QCO, CO/CO₂ shows all mentioned changes. Indicators have predictable values, timely indicate all mentioned changes that longwall face passed through, and they overlap each other very well. During the process of reoxidation of fire all indicators had significantly high values, due to intensity and force of fire upon reactivation. Upon the sealing of the area a decrease and stabilization of parameters took place.

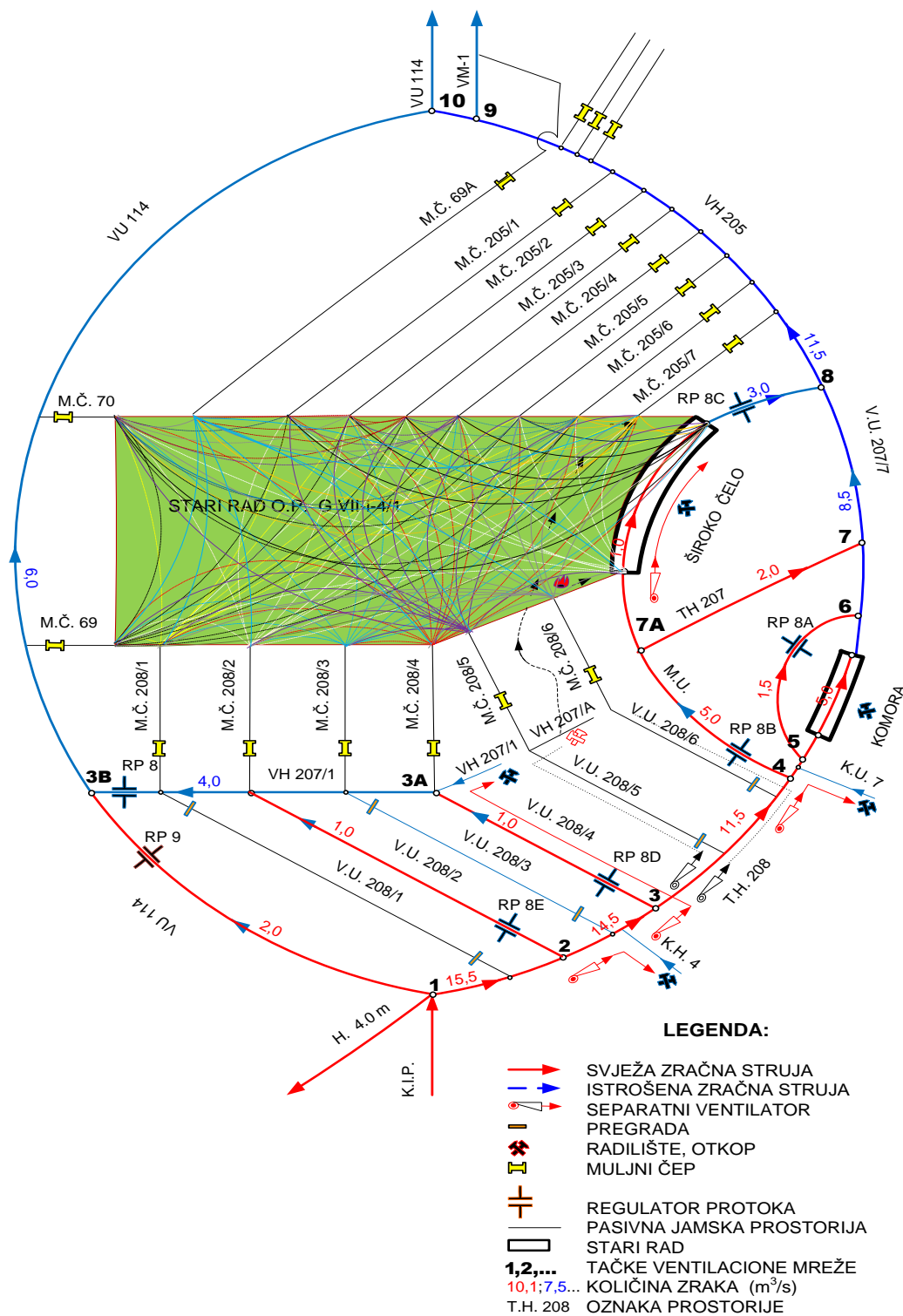

Figure 6. Canonic ventilation scheme of the Eastern part of Raspotočje mine (TB-IV) upon reclosure of the connecting rises VU-208/5 and VU 208/6 and construction of assembly rise (MU); Status on December, 2002 [1] (Graphical analysis of possible air flow lines (migration) through the gob area of longwall face)

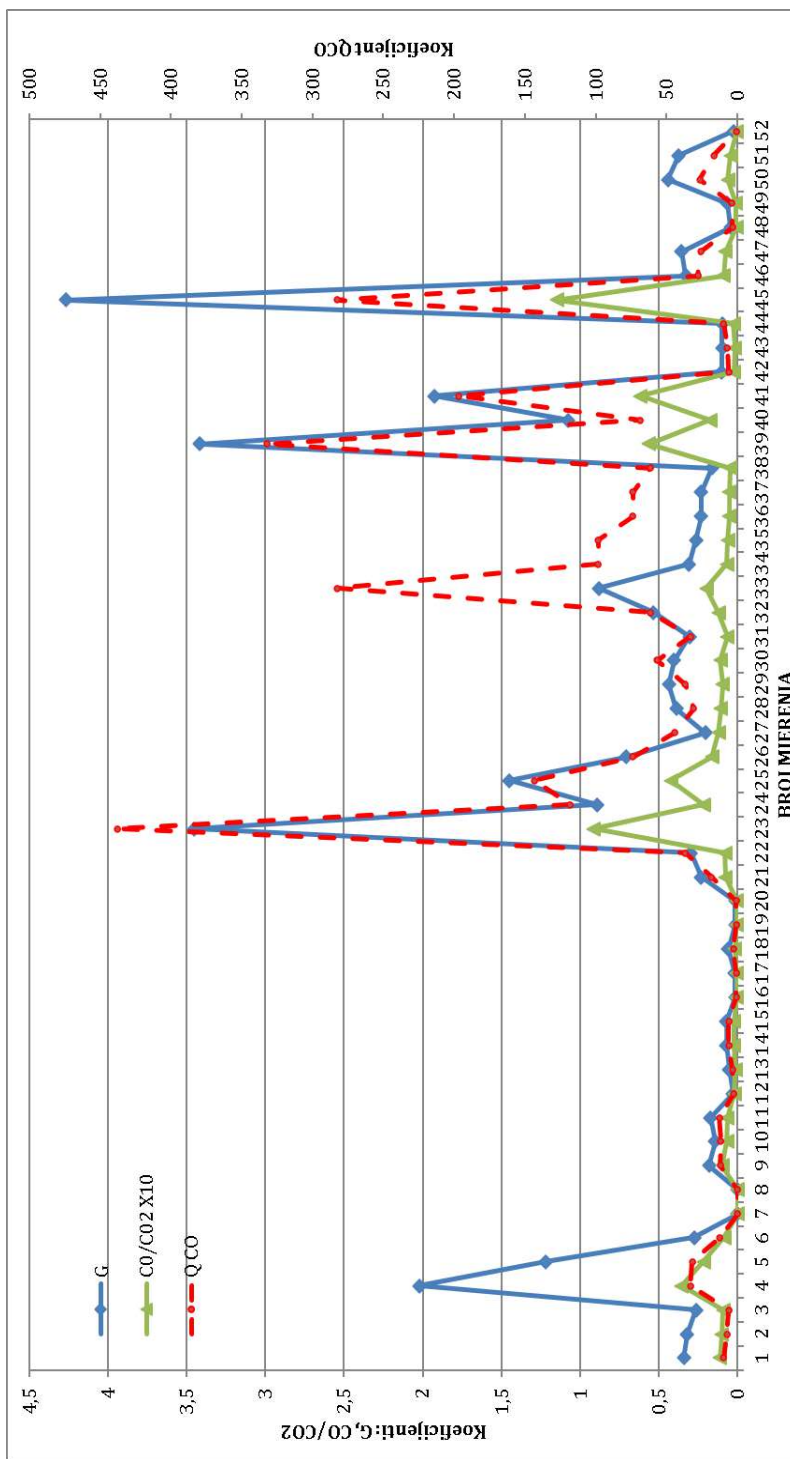

Figure 7. Comparative diagram of fire coefficients : G, Q CO, CO/CO₂, at the exit from longwall face (ŠĆ)

CONCLUSIONS

Longwall face method applied in underground operations of Zenica coal mine include roof caving into the mined out voids, without stowing of mined out areas. Consequences of such mining methods include significant air flow (migration) through mined out space (gob) of the longwall workings. Such air migrations often resulted in occurrences of spontaneous oxidation and development of endogenous fire in gob area of the longwall face, especially in situations that include poor management of fire prophylactic measures (unnecessary directing of increase air quantities through longwall face, bad management of ventilation screens for prevention of air flow in lower and upper chamber of longwall face, untimely closure of rooms upon completion of operation at longwall face, collapsing of safety pillars between mining panels due to insufficient width of pillars, and other) [1].

Prime disadvantage of advancing mining method is increased usage of consumption of depression due to length of ventilation ways (increased length of panel opening corridors), and creation of a large number of potential lines of air flow (air migration lines) through the gob of longwall face, between the sealing objects, as well as between sealing objects and longwall face line. One of the solutions to the problem is development of working panels with less connections in the panel itself, especially connections driven through safety pillars toward the adjacent panels. That would decrease number of sealing objects and possible air migration lines through the gob of the longwall panel.

Complexity of endogenous fires occurrences in underground operations of Zenica coal mine require implementation of efficient measures and procedures for their suppression.

The efficiency of the measures and technologies for open fire controlling are mostly dependent on the location, status, and duration of the fire. Intensity and duration are also dominating factors for the better efficiency of the measures. Effective techniques require a better understanding of the strengths and limitations of each measure and the behaviour of the fire, and a realistic work programme based on the extent and rate of progress of the fire [6].

Analysis of fire in mine operations of Zenica Brown coal mines that occurred during the mining of the main coal seam (GUS) using longwall method showed that application of a single protection method or procedure is not sufficient for suppressing endogenous fires [1] [2]. The success can be expected only by applying a combination of various protection measures and procedures, otherwise applied measures would not yield required results.

REFERENCES

- [1] Kurbašić R.: Grafoanalitička metoda analize kompleksa aktivnih i pasivnih mjera zaštiti od podzemnih rudničkih požara, doktorska disertacija, RGGF Tuzla, avgust 2019.
- [2] Kurbašić R.: Položaj ventilacionog hodnika kod širokočelnog otkopavanja u funkciji gasne i požarne opasnosti, Magistarski rad, RGGF Tuzla 2004.
- [3] Marković J., Kurbašić R., Karadžin Z., Velić A.: Influence of various longwall face ventilation regimes on spontaneous mine fire occurrences and increased gas release in „Raspotočje“ mine of Zenica brown coal mines, Journal of Faculty of Mining, Geology and Civil Engineering 2022/10, pp.41-48, DOI 10.51558/2303-5161.2022.10.10.41.
- [4] Marković J., Mićević .S: Požari u rudnicima uglja, RGGF Tuzla, 2005.
- [5] M. J. Mc Pherson: Subsurface fire and explosions, Subsurface ventilation and environmental engineering (Chapman & Hall Publication, London, 1993.
- [6] N. Sahay, A. Sinha, B. Haribabu, P.K.Roychoudhary: Dealing with open fire in an underground coal mine by ventilation control techniques, Journal of the Southern African Institute of Mining and Metallurgy 114 (6), pp. 445-453, 2014.
- [7] Ray S.K, Singh RP, Sahay N, Varma N.K: Assessing the status of fire in underground coal mines, Journal of Scientific & Industrial Research 63 (7), pp 579-591, 2004 .
- [8] Tehnička dokumentacija RMU Zenica.

MECHANISED COAL EXPLOITATION IN THE "BREZJE" PIT OF THE "DJURDJEVIK" BROWN COAL MINE

Šefik Sarajlić¹, Omer Musić²

ABSTRACT

In addition to the coal and electricity market and changing geopolitical circumstances, there are other sufficiently rational reasons for opening new underground mining facilities and modernizing existing mining methods. Significant limiting factors and influences, in complex mining-geological conditions, most significantly affect the possibilities of the mechanized way of mining brown coal. The "Brezje" pit is a part of the deposit where the mining-geological factors are complex and determined by the natural conditions of the deposit's genesis. Excavation methods and technologies in complex deposit conditions must be based on great flexibility and adaptability. The complexity of the tectonic structure in the "Đurđevik" pit justified the application of chamber excavation methods with borehole blasting, in various technical modifications and solutions. In all previous solutions, the degree of mechanization of the method was not significantly improved and all modifications of the chamber method were non-mechanized or semi-mechanized with a large participation of manual work, technology based on drilling and blasting, high risk of injuries, low utilization of deposits, unjustified economic effects of work.

The aim of this paper is to give an adequate answer to the hypothesis "in the block structure of the deposit with pronounced tectonics, it is possible to reduce the unfavorable influence of the complex mining-geological factors of the deposit on the excavation method by choosing modern mechanization for underground exploitation". The mechanized chamber method of excavation is a conceptual solution for the possible application in complex conditions of the proposed flexible mechanization for work in the "Brezje" pit. The advantage of modern multifunctional mining machines is a high degree of adaptability to the elements of the coal layer with the use of different working mechanisms (tools) that can be changed in a very short time depending on the working phase of the process.

Key words: Pit, complexity, factors, chamber method, flexible, multifunctional machine

1. THE COMPLEXITY OF THE MINING-GEOLOGICAL CONDITIONS OF THE „BREZJE” AREA

The area of the pit „Đurđevik“ is a smaller part of the general tectonic complex of the Đurđevik basin, where tectonics was intensively reflected. The disturbance of the layer is different in certain parts of the deposit, so the continuity of the coal layer is interrupted and the passage from one block to another is possible only through barren fault zones. The faults are of variable intensity, they break the coal seam, closing one coal block with amounts from 100.000 to 2.5 million tons. In the area of the „Brezje“ district, a large number of faults were found that break the continuity of the coal seam, and the general complexity is difficult to follow. The complexity is reflected especially in the small dimensions of the mining blocks of the possible mining fields and excavations, pronounced tectonics and variable elements of the coal seam. The distribution of faults can be seen on the structural map of the „Đurđevik“ basin and the „Brezje“ region (figure 1), as well as on the characteristic geological profile (figure 2).

¹Master's degree in mining engineering, RMU „Đurđevik“ d.o.o. - Đurđevik; sefik.sarajlic@rudnikdjurdjevik.ba

²Full professor, Rudarsko-geološko-građevinski fakultet „Tuzla“; omer.music@untz.ba

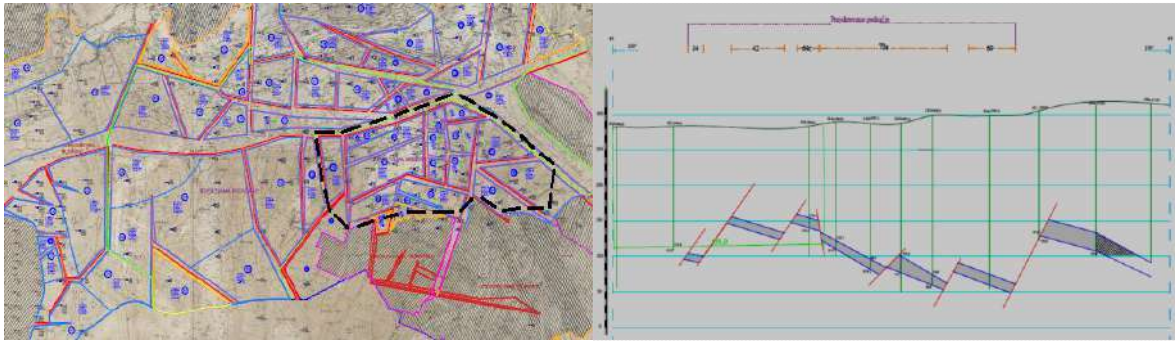

Figure 1. Structural map of the „Durdevik“ basin **Figure 2.** Characteristic geological profile (49-49') and the „Brezje“ region

From a tectonic point of view, the „Durdevik“ coal basin area has been strongly tectonically shaped on several occasions. Strong tectonic activity was carried out in several phases over a long geological time in an area where there are masses of rock with different physical and mechanical properties in a relatively small area, which caused the formation of specific deformations with considerable movement of rock masses.

1. INFLUENTIAL FACTORS ON COAL MINING IN COMPLEX MINING-GEOLOGICAL CONDITIONS

In researching the possibility of a mechanized way of preparing and digging brown coal in the complex mining-geological conditions of the „Brezje“ pit there are significant limiting factors and influences that need to be adequately addressed. The mining-geological factors of the deposit (picture 3) are prerequisite for all research into possible methods and technologies of excavation in the pit in order to plan and design new capacities for the exploitation of deep reserves that will not be mined by surface exploitation. All future excavation methods and technologies must be based on great flexibility so they can adapt to deposit conditions, a significant degree of process dynamism and equipment manipulability, in order to achieve the necessary justification of exploitation within the framework of small capacities (coal blocks of variable thickness and layer inclination), satisfying the economic indicator while improving the degree of utilization of deposit and ensuring a high degree of safety at work. Mining-geological factors are determined by the natural conditions of the deposit's genesis, but with the correct choice of technical-technological factors, it is necessary to minimize or exclude negative influences on the possibility of applying the method or reduce it to a rational measure. Therefore, it is immediately necessary to define the most significant influencing factors and boundary conditions on the possibility of applying the mechanized excavation method in the "Brezje" pit.

2.1. Selection of mining-geological and technical-technological influencing factors

Geological reserves of coal in the tectonic blocks of the "Brezje" pit amount to 6.4 million. tons. The exploitation field of the pit has approximate dimensions of 1,000 x 400 m or a total area of approx. 400,000 m² of the productive part of the deposit. Total exploitation reserves in the "Brezje" area amount to 4.5 million tons. The thickness of the layer has a multiple influence on the choice of the excavation method and is reflected in the adjustment of the basic dimensions of the excavation, the method of rehabilitation of the excavation space in the process of roof management and the direction of excavation. The thickness of the coal layer in the "Brezje" pit is very variable and ranges from 4.05 m (block 66 b) to 22.25 m (block 62 b), as determined by investigative work. In the "Brezje" area/pit, there are blocks of great thickness and a variable angle of bedding, so their dimensions and the slope of the layer's extension and fall require modern flexible equipment and mechanization. The natural conditions of exploitation in the "Brezje" pit are characterized by the natural tendency of coal to self-ignite, very rare occurrences of methane, and due to high humidity, the slight presence of dangerous coal dust. The coal belongs to hard brown coal whose individual components correspond to the components of hard coal. The complexity of mining-geological factors causes an appropriate choice of technical-technological ones that influence the application of mechanization in the designed method in the "Brezje" pit (figure 3.)

The hydrogeological characteristics of the deposits show, based on the characteristics of the roof deposits and the results of exploratory drilling, that in an undisturbed state the roof deposits are weak collectors of groundwater. However, surface water reaches the mining works through the system of cracks, caverns and faults and infiltrates the pit rooms as underground water, and when the underground works reach the fault zones, they enter the mining works.

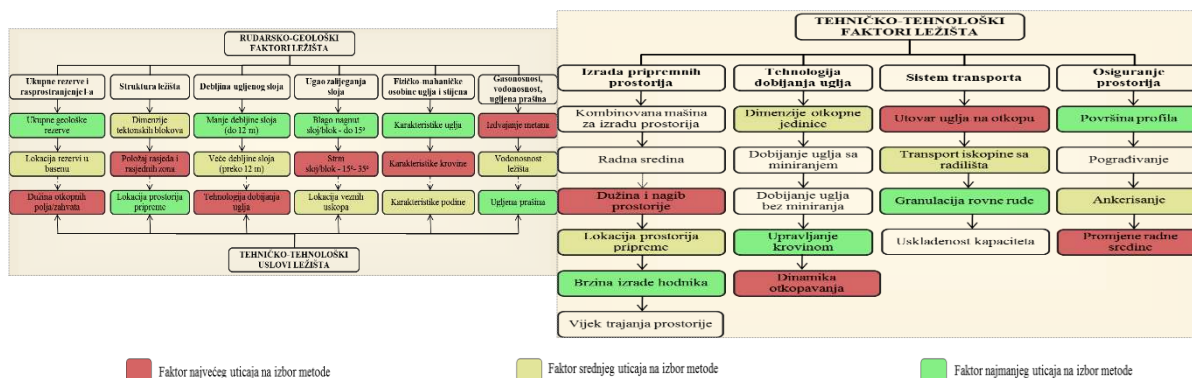

Figure 3. Selection of mining-geological and technical-technological factors by degree of influence on the choice of method

2.2 Selection of organizational, security and economic influencing factors

Organizational factors are very closely related to technique, technology and work efficiency and include the organization of work on preparation and excavation, transport and ventilation systems, crews on multifunctional machines, conformity of capacities and conformity of technological phases. Safety factors correspond to the mining-geological conditions of the deposit with adequate measures to ensure safety and protection at work. They define measures in the area of providing measures to control the gas condition, drainage, dangerous coal dust, securing premises and working comfort, measures related to the geomechanical characteristics of the working environment. The economic factors of opening the „Brezje“ pit are mostly geopolitical, they determine the limits of realistic possibilities for opening and exploitation and exclude a technical, technological and economic approach to considering and defining the decision on justification. However, there are other, relatively more numerous factors, which support the justification of opening a new pit, and the economic evaluation shows the justification of opening the „Brezje“ pit with significant positive effects.

3. CHAMBER METHOD OF EXCAVATION WITH DEEP WELLS

In the „Đurđevik“ pit, there were changes in excavation methods throughout the periods of work and development. In the period when the pit was shallow and the deposit conditions were more favorable (with a minor influence of tectonics), variants of Š.Č method were used (until 1990). The specificity of the mining-geological factors, and especially the tectonics of the deposit, has conditioned the application of the chamber method of excavation with a variety of deep mine wells (from 1991 to the present), as a method that is adaptable to the natural conditions in the deposit. The goal has always been how to choose a rational system of excavation and to achieve better work results through the improvement and modernization of the process, in order to economically justify the existence of pit exploitation. The technical solution of the new excavation method is based on a certain practical experience and positive legacy of coal exploitation in complex mining-geological conditions in the „Đurđevik“ pit in the mentioned period of development, which is characterized by the application of several variants of the chamber method with a variety of deep mine boreholes. The chamber method underwent developmental modifications and was limited to the excavation of a coal layer with a thickness of 10 to 13 m, until 2020, when the mine innovated the chamber excavation method in the tectonic blocks of the „Živčići“ area, which defines the method of chamber excavation in conditions of increased layer thickness (from 13m to 25m) by deep borehole blasting.

3.1 Basic parameters of the chamber method of excavation by deep-well blasting

Due to the large thickness of the coal seam, in addition to DOH-1 and GOH-1, it is necessary to construct auxiliary pits POU-1 and POH-1. POU-1 is made from GOH-1, and the purpose of the room is to achieve a sufficient height difference compared to GOH-1 and DOH-1. POH-1 is made 8 to 10 m from the roof of the coal seam and 6 to 10 m from the elevation of GOH-1 in the middle, between DOH-1 and GOH-1. The opening of the trench is made from the prepared average DOH, GOH and POH length of 4 to 5 meters, from which mine holes are drilled for the opening of the trench by parallel blasting of the fan at the opening of each OH. After the excavation is opened, coal is obtained by blasting a fan of mine wells with 2, 3 or 4 partial fillings. After the blasting of each fan, separate ventilation of the work site is carried out, and coal is transported from the mining unit. OJ should be led so that the corridors end at the same distance from SU, without the collapse of one OH taking precedence over the other two OHs.

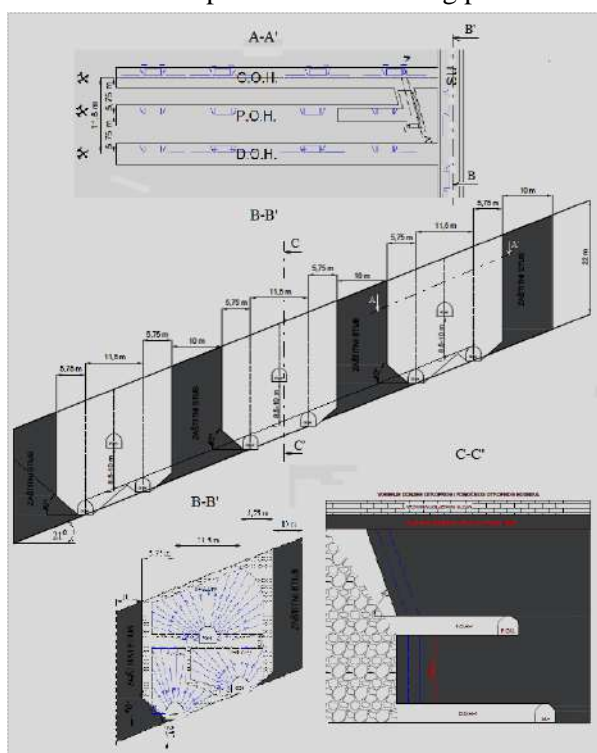

Figure 4. Chamber method with deep-well blasting

Coal will be transported from the mining unit with double-chain rake conveyors type DGT-440. Loading of demined material is done by self-loading, gravity rolling and sliding of demined coal from the chamber onto the rake conveyor, and by raking on the sides. The ventilation of the work site is carried out from the flow system of ventilation of the pit, with separate fans. For the organization of the phase of excavation using the chamber method with deep-hole blasting, three working groups at OJ per shift are needed.

4. NEW EXCAVATION TECHNOLOGIES APPLICABLE IN THE CONDITIONS OF THE „BREZJE“ PIT

No matter how advanced mining science, technique and technologies are, sometimes it is difficult to find technical solutions that will meet all the conditions and requirements of rational (safe and techno-economically justified) exploitation of coal in the pit. Modernization and mechanization of the technological process in the phase of excavation in the pit always brings improvement through a higher level of mechanization, humanization of work, increased dynamics of excavation, higher degree of utilization of coal reserves, improvement of safety while reducing the risk of injuries at work, as well as significant improvement of the economic effects of work.

Table 1. Parameters of the chamber method

Excavation Unit (OJ)		
DOH-1 (lower excavation corridor)		
GOH-1 (upper excavation corridor)		
POU-1 (auxiliary excavation corridor)		
POH-1 (auxiliary excavation corridor)		
The thickness of the coal seam	m	15-30
The length of excavation	m	50
Excavation width	m	25
Excavation unit width (OJ) - max	m	17
Height of excavat. unit (OJ) - max	m	23
Width protect. interventricular column	m	28
Choir. distan. between DOH and GOH	m	7-10
Parameters of drilling blasting- fans	m	11,5
Area - Σ (DOH, GOH, POH)	I+II+III	
Number and length of wells (Nw/Lw)	m ²	591,6
Amount of explosives	/m	110/288
Number of lighters	kg	256,6
Amount of air at OH	kom	329
Number of employ. on site- 3 sit.x4 sit.	m ³ /s	2,37
Number of cycles per day on excavation	empl.	12
Utilization. of coal in OJ	cyc/day	0,66
Utilization. of coal in the mining field	%	86
Productivity (t.r.u./working/month)	%	55,53
The thickness of the coal seam	t/empl	335

4.1. Key parameters of the existing and proposed solution of the chamber excavation method

Table 2. Comparative conceptual parameters of the existing and proposed solution of the excavation method

Parameter – Indicator	Modified chamber excavation method with deep borehole blasting	Mechanized chamber method of excavation with multifunctional machines
Method of making preparatory rooms	The method of production is not set as a condition - at the level of non-mechanized classical production	Mechanized method of production
Adaptation to complex mining and geological conditions	High degree of customization	High degree of customization
Achieving the maximum possible degree of utilization of the coal seam	A significant improvement in the degree of utilization compared to earlier variants of chamber methods	A significant improvement in the degree of utilization compared to earlier variants of chamber methods
Reduction of the cost of manual labor in the phase of obtaining coal and increase of the mechanization of work	Manual work has not decreased, especially the volume of drilling and blasting work has increased	Manual work significantly reduced, all phases of work are carried out mechanized by the use of connecting mechanisms on the machine
Increase of working effects on OJ (chambers) - productivity of the unit and work productivity,	Work efficiency increased due to the productivity of OJ, but the number of workers is higher due to the management of three excavation corridors (chambers).	Work efficiency increased due to the geometry of the excavation unit, the number of workers significantly reduced (the crew on the machine does everything)
Improvement of safety working conditions at the mining unit	Due to the significant participation of manual labor and the large number of workers in the operation, the risk of injury has not been reduced	Due to the reduced participation of manual labor and the smaller number of workers in the operation, the risk of injury is significantly reduced
Improving the economic effects of work	Improved economic effects of work	Significantly improved economic effects of work

1.2. Conceptual solution of the mechanized chamber excavation method in the “Brezje” pit

The mechanized chamber mining method using multifunctional mining machines is a universal mining method regardless of the thickness of the coal block/layer. Given that in the „Brezje“ district, a large number of coal blocks have a thickness of less than 13 m, the aspiration is to define a method for the entire district, where the mechanized method has significant advantages. Comparative conceptual parameters of the existing and proposed solution of the excavation method are given in Table 2. Due to the complexity of the mining-geological conditions, the size of deposits and coal blocks, the thickness and slope of the coal seam, it is not possible to rationally apply the broad-front mechanized method. By introducing a mechanized method of excavation, the key requirements of a rational system will be met, and the equipment that will be used will be in accordance with the influencing factors on the choice of method.

1.3. Basic parameters of the mechanized chamber excavation method

Based on previous research and analysis, it is possible to give a rational proposal for equipment and mechanization for the mechanized chamber method of excavation, and the conceptual solution of the method, and based on clear criteria for the specific dimensions of the excavation unit and the safety pillar, the technology of work at the excavation site, the organization of work and some production – economic parameters.

4.3.1. Multifunctional mining machine – features and capabilities

The machine is designed on tracks for rehabilitation and reconstruction of pit rooms and leveling of swollen floors of rooms in the pit, in the version with a loading bucket and an active bucket it is used for loading the excavation. In the version with a hydraulic hammer, it is used for the destruction of the working environment (destruction of coal and accompanying rocks), and in the version with a hydraulic drill for drilling holes for explosives and anchor bolts, as well as with a cutting head for shaping and bringing it into the designed profile of the room. The machine can be supplied for different voltages according to the customer's wishes. Equipped with an LCD screen to view operating conditions and error warning messages. All data is stored on the SD card.

As a mining machine to be used for mechanized chamber mining of coal:

- the machine will also be used for the creation of pit rooms (OH), the surface of the light profile of the corridor ($F_s=10.5 \text{ m}^2$)
- the excavation machine will excavate excavation blocks with a maximum reach of (8,634 x 8,065) m,
- obtaining coal will be done by cutting in the phase of opening the pit (with a cutting head as the working mechanism) and processing the pit with a hydraulic impact hammer and drilling (the working organ is a hydraulic drilling tool)
- the mining machine has a device for knocking down coal dust, which is created during the mechanical destruction of coal; - the engine and all electrical devices of the digging machine are in safety design (Ex);
- the characteristics of the excavation machine (load on the floor, cutting force, angle at which the machine can work, etc.) correspond to the characteristics of the working environment of the „Brezje“ pit;
- the excavation conveyor that will be used on the mechanized chamber method corresponds to the capacity of the excavation machine, it is easy to mount, extend, shorten, occupy little space under the machine, and its length must correspond to the length of the excavation block, i.e. to the maximum length of OH.
- by its design, the machine meets the requirements of group I category M2 (EU Directive 2014/34/EU) and can be used in mines with hazardous atmospheric conditions 2 according to ČSN EN 1127-2 (EN 1127-2) and in areas with a risk of methane explosions and coal dust.

Figure 5 shows the combined machine multipurpose dinting loader type KL-PSU9000-II-EN

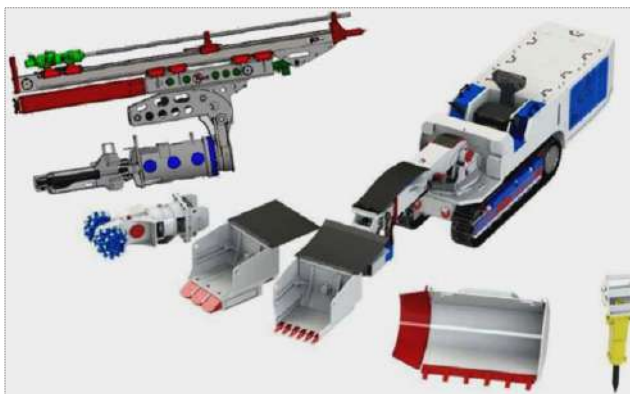

Figure 5. Machine with connected working mechanisms

Table 3. Basic machine parameters

Parameter/Characteristic	Size
Mass with a spoon	9.680- 9.870 kg
Table with a hammer	9.230 kg
Table with cutting head	9.650 kg
Table with drilling accessories	11.450 kg
The length of the machine with mechanism. (min-max)	6.287- 9.572 mm
Machine width	1.216 mm
Machine height	1.358 mm
Chassis ground clearance	300 mm
Electric motor power	55 kW
Specific floor pressure	8,7 N/cm ²
Driving speed	0,7 m/s
Transverse force	70 kN
Along. floor slope during operation	-20°/+20°
Max. trans. floor slope	-10°/+10°
Cooling	ulje/zrak
Nominal working pressure	19 MPa

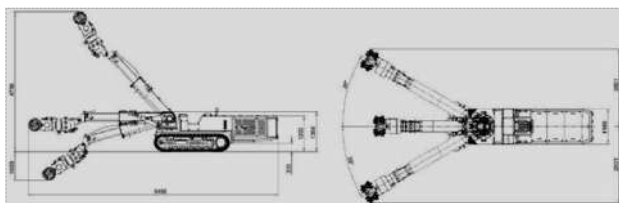

Figure 6. Machine with connection mechanism - cutting head

Table 4. Basic parameters of the machine with a cutting head

Parameter/Characteristic	Size
Mass	9.650 kg
Main dimensions (hwxwl)	1358x1180 x7706 (8.456)
Horizontal. angle of rotation	±30°
Rotation of the cutting head	2x180°
Max. reach height above the floor	4.738 mm
Max. reach depth below the floor	1.000 mm

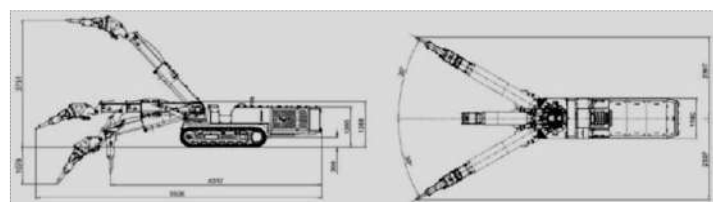

Figure 7. Machine with connecting mechanism - impact hammer

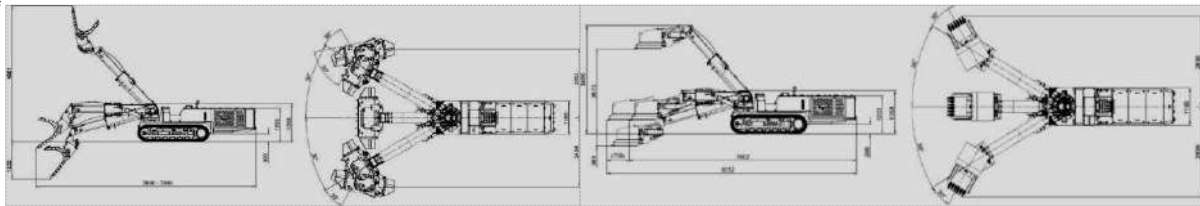

Figure 8. Machine with attachment mechanism - side and front loading bucket

Table 5. Basic parameters of the machine with connected active mechanisms - hammer and loading bucket

Parameter/ Characteristic	Hammer mechanism	Mechanism with loading bucket	Mechanism with active bucket
The lower edge of the stroke at the maximum lifting of the arm	3.235 mm	3.235 mm	2.673 mm
The lower edge of the stroke at the maximum lifting of the arm	3.751 mm	3.613 mm	3.405 mm
Maximum walking reach height	-	4.861 mm	4.005 mm
Lateral reach of bucket/hammer	2x2.397 mm	2x2.453 mm	2x2.836 mm
Maximum reach below floor level	1.079 mm	1.333 mm	600 mm
Maximum arm rotation angle	30°	30°	30°
Maximum bucket rotation angle	-	-	30°
Arm extension	750 mm	750 mm	750 mm
Volume of the spoon	-	850 l	300 (350) l
Bucket height	-	1.430 (2.170) mm	830 mm
Max. height of the upper edge of the tipping bucket	-	3.600 mm Max.	-
Maximum tipping angle of the bucket	-	50°	-
The maximum angle of inclination of the bucket	-	65°	-
Penetration force on the bucket tooth	-	-	150 kN
The length of the machine - the tip of the hammer in the horizon. hand position	7.758-8.508	-	-

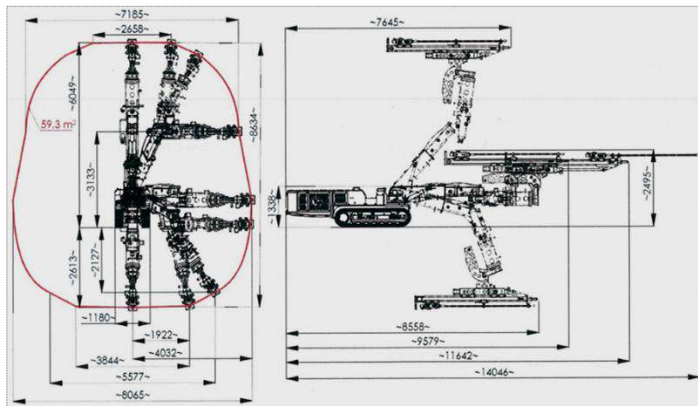

Figure 9. Machine with connecting mechanism – hydraulic arm for drilling

Table 6. Characteristics of a machine with a hydraulic arm for drilling

Parameter/ Characteristic	Size
Mass	11.450 kg
Main dimensions (h x w x l)	11.642/14.046
1,216 x 1,180 x 9,579	
Horizontal angle of rotation	±30°
Horizon. impact hammer rotation	0°+90°
Vertical rotation of the impact hammer	±180°
Max. field of coverage/ profile	59,32 m ²
Drilling length	2.400 mm
Max. height reach (horizontal)	6.049 mm
Max. height reach (vertical)	4.032 mm
Extending the telescope	750 mm

4.4. Geometrical parameters of the mechanized chamber excavation method

Based on the research of the conditions and technical capabilities of the machines, the constructive parameters of the excavation method were determined. Modern equipment and machinery available on the market for underground coal mining will reduce the impact of natural unfavorable deposit conditions on the application of efficient mining methods and technology.

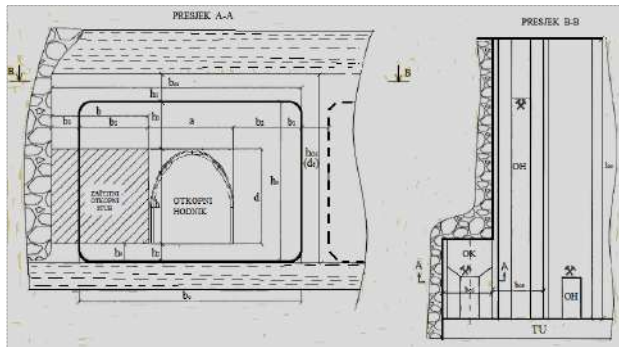

l_0 ; b_0 ; h_0 - length, width and height of the excavation chamber
 b ; h – width and height of the protective pillar;
 a - width of excavation column;
 d - layer thickness;
 h_3 - height of the ceiling;
 h_2 - the depth of the subfloor;
 h_3 - thickness of the ceiling protective plate;
 b_1 - thickness of protective barrier;
 b_2 - depth of lateral engagement

Figure 10. Geometry of the excavation chamber

With the excavation chamber, it is necessary, for the defined depth at which the excavation is carried out and the height of the OK, to determine the other two dimensions, the length "l" and the width "b" of the excavation chamber, by mathematical and analytical means.

Optimization of the excavation chamber height

The height of the excavation-chamber is not determined by calculation and is adopted. The height of the excavation chamber is affected by the thickness of the coal layer, the levels in thick and steep layers and the size of the vertical reach of the mining machine, so that in thick layers.

$$h_s = \sum_{i=1}^{i=n} h_i + h'_i + h''_i$$

h' - thickness of the protective plate in the ceiling (m)

h'' - thickness of the protective plate in the floor (m)

The height of the excavation chamber is determined at the beginning of the research and represents one of the main limiting parameters in the selection of the excavation machine.

Optimization of the width of the excavation chamber

In the case of inclined layers and variable terrain configuration, as in the example of the "Brezje" pit, the depth of the deposit changes as the layer falls. The depth limit for the adopted width of the excavation chamber is determined mathematically

$$H = \frac{\sigma_0}{K_p \cdot K_s \cdot \gamma_k} \sqrt{\frac{b}{h}} \quad H = \frac{233,2}{2,25 \cdot 1,35 \cdot 1,38} \sqrt{\frac{16,2}{18,2}}$$

H (m) - excavation depth, $H=220-320$ (m); corresponding limit depth $H=250$ m

Determining the length of the excavation corridor from the conditions of the coefficient of machine working time

To determine the length of the excavation corridor for excavation - using the machine, we will use the form from the conditions of daily production from the excavation according to the coefficient of the machine's working time.

General expression for the length of excavation:
$$l = \frac{q_p \cdot n_{sm} \cdot T_{sm} \cdot 60 \cdot k_m}{n_c \cdot r \cdot m \cdot \gamma} + l_n \text{ (m)} \quad (k_m=0,49-0,67)$$

Mining front productivity

The productivity of the excavation front is expressed in tons per meter of the excavation front of the pit, the horizon of the excavation field or excavation, and is determined by a mathematical expression: $q_p = P_0 / Nn \rightarrow \max$;

When the thickness of the protective coal plate towards the roof is 2.0 m, the step of submergence in the chamber excavation is 7,06 m.

Work system on the mining unit

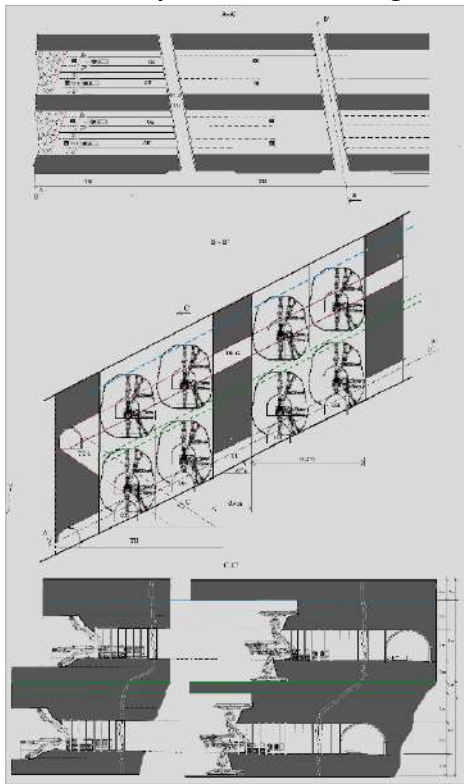

Figure 12. Mechanized chamber method

The geometry of the excavation chamber (8.1 x 8.6) m, shows that the multifunctional machine is applicable in blocks (8-12) m, when applied in one operation, and it is possible to apply two machines in parallel operation. Excavation of the excavation chamber is carried out by a combination of connecting mechanisms (tools) by destroying the rock without blasting. For tectonic blocks of greater thickness (block 62a and 62b), the application of these machines is possible in two zones (lower and upper), where there must be a great coordination of the working operations of the machines in simultaneous operation in both zones, i.e. the progress of the mining work front in the excavation unit. Excavation processing consists in the formation of chambers by expanding the OH, destroying coal in the ceiling, sides and floor and it expands symmetrically from the axis to the sides by 4.05 m, to a total width of the excavation chamber of 8.2 m. The maximum height of coal destruction is 6.05 m and the depth of the floor of the excavation corridor is 2.61 m. By processing the excavation according to the height of the excavation, a protective plate is left for the roof of 2 m. The protective plate against the roof of the layer, the space in the pit where the coal is destroyed in the sides, ceiling and floor, and that after the destruction in the pit moves to a certain distance, it breaks and successive collapse of the roof occurs..

Coal production from mining

Coal production per meter of mining chamber: $Q_{mo} = F_o \cdot \gamma = 60 \cdot 1,38 = 82,8 \text{ t/m'}$

Effective working time of the machine for the destruction of 1m' excavation chamber: $t_{ro} = 120 \text{ min}$

Excavation chamber progress: $L_{ns} = T_{smj} / t_{ro} = 450 / 120 = 3,75 \text{ m/ shift}$

Due to operational downtime, we adopt 70% of the calculated excavation shift progress: $L_{nso} = 2,63 \text{ m/ shift}$

Daily excavation progress: $L_{ndo} = 3 L_{ns} = 3 \cdot 2,63 = 7,89 \text{ m/day}$

Coal production per meter of chamber excavation: $Q_{mo} = F_o \cdot \gamma = 60 \cdot 1,38 = 82,8 \text{ t/m'}$

Daily coal production from mining: $Q_{mdo} = Q_{mo} \cdot L_{ndo} = 82,8 \text{ t/m'} \cdot 7,89 \text{ m/day} = 653,3 \text{ t/day}$

Monthly coal production from mining: $Q_{mmo} = 30 \cdot Q_{mdo} = 30 \text{ day} \cdot 653,3 \text{ t/day} = 19.600 \text{ t/month.}$

Coal production indicators refer to 1 mining mechanized chamber. For a layer of great thickness (20 m), 4 excavation chambers are calculated in simultaneous operation.

Utilization of the coal seam

The utilization coefficient represents the ratio of coal produced from the mining unit per m' of the mining chamber in relation to the calculated amount of coal per m' (according to the geometry of the mine).

$$I_u = \frac{Q_{mo} \cdot N_{ok}}{Q_{gmo}} = \frac{82,8 \text{ t/m' } \cdot 4}{16,2 \cdot 20} = \frac{331,2}{447,12} = 74,1 \text{ \%}$$

Effects

Monthly coal production from preparation: $Q_{mmp} = 30 \cdot Q_{mdp} = 30 \text{ day} \cdot 134,9 \text{ t/day} = 4.047 \text{ t/month}$

Monthly coal production from mining: $Q_{mmo} = 30 \cdot Q_{mdo} = 30 \text{ day} \cdot 653,3 \text{ t/day} = 19.600 \text{ t/month}$

Total monthly production of coal from preparation and mining: $Q_{mmu} = Q_{mmp} + Q_{mmo} = 4.047 + 19.600 = 20.647 \approx 20.650 \text{ t/month. Monthly and annual output per employer:}$

$$U_{mr} = \frac{Q_{mmu}}{N_{rad}} = \frac{20.650}{128} = 161,32 /empl./mon. = 1.935,8 /empl/year.$$

Table 8. Parameters of the borehole blasting method and the mechanized method

Parameter – Indicator	Modified chamber excavation method with deep borehole blasting	Mechanized chamber method of excavation with multifunctional machines		
The method of making preparatory rooms	Classical method (drilling and blasting method)	Mechanized method of production (machine)		
The length of the dissolution process	L=52 m	L=120 m		
Excavation width	Š=90 m	Š= 52 m		
Cross profile of the excavation unit (chamber) - for lz=17 m	$F_o=(23 \times 17)m$; $F_o \cong 390 \text{ m}^2$	$F_o=(8,6 \times 8,1)m$; $F_o \cong 70 \text{ m}^2$ za 2 pojasa $(2 \times 2) \times 70 \text{ m}^2$; $F_o \cong 280 \text{ m}^2$		
Excavation processing and management	By drilling and blasting in three fans of mine boreholes (I, II i III)	A multifunctional machine with a combinat. of attachment mechanisms (tools)		
3 fan wells (1 cycl.- 1,6 m')	DOH GOH 3 fan wells (1 cycl.- 1,6 m') DOH	GOH		
	Surface [m ²] - 591,6; A well N_w/L_w ; [/m] - 110/288 Explosive [kg] - 256,6 ; Lighters [kom] - 329			
Production parameters	(1 cycle - 1,6 m')	(1 cycle - 2,4 m')		
Time - 1 cycle on excavation	$t_c= 27$ hours za 1,6 m' excavations	$t_c= 7,3$ hours za 2,4 m' (per chamber- mach.)		
Broj smjena u ciklusu	$B_{sm}= T_c/T_{ef}= 27/6= 4,5$ smj./cikl.	$B_{sm}= T_c/T_{ef}= 7,3/7= 1,04$ smj./cikl.		
Coal production per cycle	$Q_{ug/cik}= D_z \cdot P \cdot \gamma = 1,6 \cdot 313 \cdot 1,38 = 691 \text{ t}$	$Q_{ug} = D_z \cdot P \cdot \gamma = 232 \text{ t}$ (per chamber- mach.) -for one belt- (2 machines)- 464 t/cycle - for two belts - (4 machines - 928 t/cycle)		
Coal production per shift	$Q_{m'} = Q_{ug/cik}/B_{cik}= 156,3 \text{ t.r.u./shift}$	232	Coal production per shift	$Q_{m'} = Q_{ug/cik}/B_{cik}= 156,3 \text{ t.r.u./shift}$
Coal production per month	14.067 t.r.u./month	20.880	Coal production per month	14.067 t.r.u./month
Number of excavation employers	14 empl./day (po OH)x 3= 42 empl./day	8 empl./day (po OH)x 4= 32 empl./day		
Productivity (t.r.u./employ./month)	335	653	Productivity (t.r.u./employ./month)	335

CONCLUSION

- At the time of the challenges of the European energy transition, the decarbonization of the BiH energy sector, but when the political circumstances are rapidly changing and there are no strategic political decisions, considering the opening of new underground mining facilities and the modernization of methods and technologies, there are enough rational reasons.
- In the complex mining-geological conditions of the „block deposit structure“, there are significant limiting factors and influences that need to be adequately addressed and are key to the choice of method and technology for the exploitation of a complex deposit such as the „Brezje“ pit.
- The application of chamber excavation methods with borehole blasting, in various technical solutions of this method in the previous period, although semi-mechanized methods adaptable to the conditions of the deposit, was technically and technologically justified, but not economically.
- In all applied solutions, the degree of mechanization of the method was not significantly improved and all modifications of the chamber method remained at the level of the semi-mechanized method.
- Adequate selection of flexible equipment and mechanization in the „Brezje“ pit will reduce the share of manual work, improve the level of mechanization, the level of deposit utilization and economic effects of work and reduce the risk of injuries at work, which are key requirements of modern business. Exploitation of a coal seam with variable characteristics is possible only by using equipment that is to the greatest degree flexible and adaptable to the changing conditions of the deposit.
- The mechanized chamber method conceptually represents a solution and a possible application in complicated conditions using modern multifunctional combined machines. The advantage of these machines is a very high degree of adaptability to the elements of the coal seam with the possible application of different working mechanisms (tools) that can be changed in a very short time depending on the need in

the existing/specific working conditions.

- Multi-purpose combined multi-functional mining machine (multipurpose mining machine – multipurpose dinking loader type KL-PSU9000-II-EN) with quickly replaceable working tools and organs (mechanisms with loading bucket, cutting head, impact hammer, hydraulic drilling mechanism), contributes to easier making decisions about application in the stages of the technological process in a pit with complex mining-geological conditions.

- The production and economic indicators of the concept of the excavation method and technology confirm the justification of investing in the purchase of a multi-purpose combined multifunctional mining machine (one or more of them) depending on the planned volume of production and/or the life of exploitation in the area/ pit „Brezje“ in the future.

LITERATURE

1. B. Genčić, Technological processes of underground exploitation of stratified deposits - Excavation methods, BIGZ Belgrade, 1973.
2. M. Osmanagić, Contemporary technologies in mining coal seams in Bosnia and Herzegovina, Tuzla, 1986.
3. M. Stjepanović, Scientific basis of optimization of the main parameters of underground exploitation of stratified deposits; Tuzla, 1990.
4. O. Musić, Front-end methods of excavation of stratified deposits, Tuzla, 2010.
5. S. Sarajlić, Optimization of the technological phases of the chamber excavation method in the pit "Đurđevik", RMU "Đurđevik", Master's thesis, Tuzla, 2013.
6. S. Sarajlić, Mechanized construction of pit rooms with the AM-50 harvester in the „Đurđevik“ Brown Coal Mine, Diploma thesis, 1989.
7. S. Okubo, J. Yamatomi, Underground mining methods and equipment, University of Tokyo,
8. M. Ivković, R. Lekovski, M. Ljubojev, Defining the system of influencing conditions when choosing a short mechanized face excavation method in coal mines, Časopis Rudarski radovi, Bor, 2011.
9. S. Sarajlić, J. Korski, O. Musić, K. Gutić, Overview and analysis of frontal excavation methods for the conditions of the new pit „Višća“ RMU „Đurđevik“, „MINING 2015“, Bor 2015.
10. S. Sarajlić, O. Music, M. Taletović; Improvement and modernization of chamber excavation in the pit „Đurđevik“ RMU „Đurđevik2“, „MINING 2013“ Veliko Gradište 2013;

FUEL CONSUMPTION OF BELAZ DUMPERS AND CARBON DIOXIDE EMISSIONS USING THE EXAMPLE OF OPEN PIT 'TURIJA' OF THE BROWN COAL MINE BANOVIĆI

Jasmin Jamaković¹, Sunčica Mašić²

ABSTRACT

This work sets out the methodology and presents the calculation results of the amount of carbon dioxide emitted into the atmosphere of the BelAz dump truck at the Open Pit "Turija" BCM Banovići d.d., based on the fuel consumption monitoring data.

Properly determined fuel consumption enables the calculation of the amount of carbon dioxide emitted and preventive measures, as well as the choice of its reduction strategy. Data collection took six months, then the data were analyzed, and thus the results were given for all dump trucks by months.

Key words: fuel, open pit mining, BelAz dump truck, maintenance, Coal Mine Banovići, carbon dioxide

1. INTRODUCTION

The main activity of the Brown Coal Mine "Banovići" Ltd. Banovići is the production, processing and trade of brown coal, which is based on the balance reserves of about 165,249,697 million tons of brown coal. Most of these reserves are intended for excavation by the underground mine exploitation (about 95 million tons), and the rest (of about 70 million tons) by the open pit exploitation. Coal is produced by the open pit and underground exploitation in two mines that operate within this company, namely: the Mine "Open Pit Exploitation of Coal" (with two open pits) and Mine "Underground Exploitation" (with one underground mine "Omazići"). After the period of delayed exploitation, reactivation was started at the Open Pit "Turija", while at the Open Pit "Grivice", a continuous exploitation is carried out from the day of opening starting from the northern outcrop to the deepest coal reserves on the south side. The open pit "Turija" was selected for the subject research.

A total of 14 dump trucks are used for transport at OP Turija, namely: 12 diesel-electric trucks BelAz 75131 with a capacity of 136 t and 2 dieselelectric trucks BelAz 75137 with a capacity of 136 t. The BelAz trucks are with dieselelectric DC traction. By a comprehensive research and collection of data on the parameters of truck transport at a specific location, it was necessary to conclude which parameters have the greatest impact on fuel consumption at constant load in driving of useful and useless minerals. In order to perform the subject analysis, it was necessary to determine the average monthly fuel consumption for each considered transport unit (dump truck). For dump trucks in the conditions of work at the OP "Turija" of the Brown Coal Mine Banovići, taking into account all relevant influencing factors, the average fuel consumption can be defined as well as measures to reduce it.

¹MA in mining engineering, RMU „Banovići“ d.d.

²Full professor, University of Tuzla, Faculty of Mining, Geology and Civil Engineering, suncica.masic@untz.ba

2. METHODS OF DATA COLLECTION AND PROCESSING

2.1 Methods of data collection

The data used in preparation of this work were taken from the database of the Department Mining Technical and Operational Preparation of the Mine "Open Pit Coal Exploitation". The data were processed using Microsoft Excel licensed by the BCM "Banovići".

	A	B	C	D	E	F	G	H	I	J	K	L	M	N	O	P	Q	R	S	T
1		Kamion	Prevezeni tonovi (m3) (t.m.)	Prevezeni tonovi (m3) (t.m.)	Išoptani ciklusi (parajoni)	Išoptani ciklusi (parajoni)	Išoptani ciklusi (parajoni)	Prosječno optično vrijeme u jednom ciklusu (min)	Prosječno optično vrijeme u jednom ciklusu (min)	Maks. dužina optične staze (m)	Šipari	Koef. mronj. i kota (gosp. f)	Broj otklona	Način tona (t)	Prosječna brzina punog kamiona (vpp/min)	Prosječna brzina punog kamiona (vpp/min)	Prosječna brzina punog kamiona (vpp/min)	Prevezeni tonovi (m3) (t.m.)	Prevezeni tonovi (m3) (t.m.)	
2	IV	B1	46320	70380	1253	1173	30	60	90	2400	LB-4; RH-2	0,025	2	6	24	5,67	33	9,17	4800	5647,1
3	V	B1	35880	53820	947	897	40	60	90	2500	LB-4; RH-2	0,025	2	6	23	5,30	31	8,61	3000	3529,1
4	VI	B1	37840	56760	978	946	33	60	90	2500	LB-4; RH-2	0,025	2	6	21	5,83	30	8,33	1920	2298,1
5	VII	B1	37800	56700	1000	945	35	60	90	2550	LB-4; RH-2	0,025	2	6	24	5,67	33	9,17	3300	3882,1
6	VIII	B1	29080	43620	805	727	78	60	90	2700	LB-4; LB-2	0,025	2	6	22	5,11	31	8,61	4680	5505,1
7	IX	B1	34440	51660	1000	861	135	60	90	2600	LB-4; LB-2	0,025	2	6	24	5,67	33	9,17	8340	9811,1

Figure 1 The layout of a Microsoft Excel Sheet in which the data has been inserted for processing

2.2 Determining of fuel consumption

The most accurate method for determining the truck fuel consumption is to obtain data from actual mining operations. However, if such a possibility does not exist, various equations and data published by the original equipment manufacturer for trucks can be used for estimation purposes. Hourly fuel consumption FC (l/h) can be determined from the following equation [1]: $FC = P \times 0.3 \times LF$ where P is the engine power (kW), 0.3 is the unit conversion factor (l/kW/h) and LF is the engine load factor (part of the full power required by the truck). Values for the truck engine load factors according to some authors in the relevant literature range from 0.18 to 0.50, while the others state values between 0.25 and 0.75, depending on the type of equipment and level of use. [1] For different engine load factors LF, the hourly fuel consumption FC (l/h) is shown in Figure 2, 3.

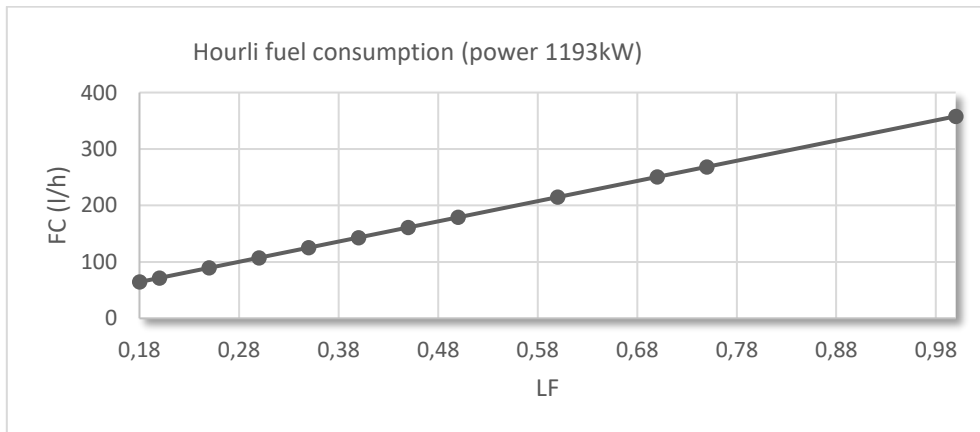

Figure 2 Fuel consumption FC (l/h) for engine load factor values (part of full power required by truck) LF = 0.18 to 1 for engine power P = 1193 (kW)

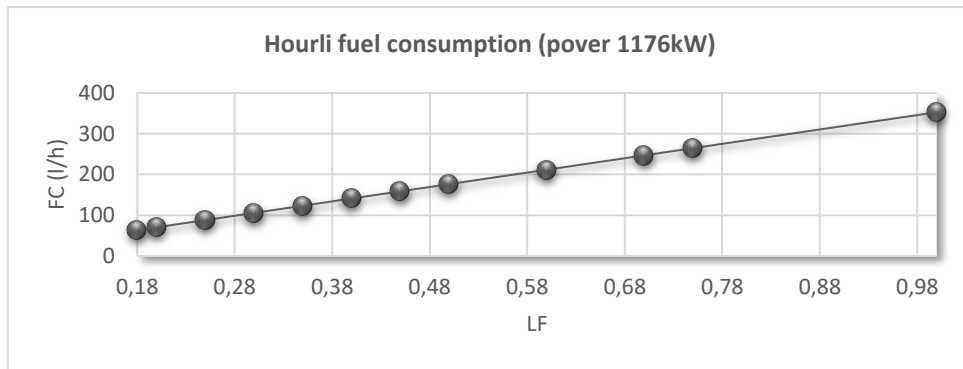

Figure 3 Fuel consumption FC (l/h) for engine load factor values (part of full power required by truck) LF = 0.18 to 1 for engine power P = 1176 (kW)

A similar equation for fuel consumption has been proposed in literature [1]: $FC = (CSF \times P \times LF) / FD$ where CSF is the specific fuel consumption for the engine at full power (0.213 - 0.268 kg/kW/h) (0.35- 0.44 lb/HP per hour), P is the power (kW), LF is the engine load factor, and FD is the fuel density (0.8318 kg/l for diesel purchased by the mine). The following values for engine load factors are recommended in literature: 25% (light working conditions), 35% (average working conditions) and 50% (difficult working conditions) [1].

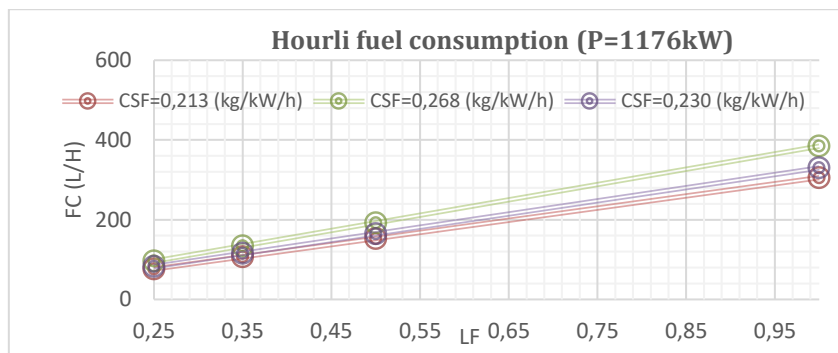

Figure 4 Fuel consumption FC (l/h) for engine load factor values (part of full power required by truck) LF = 0.25, 1.35, 0.5 and 1 for engine power P = 1176 (kW) and specific CSF fuel consumption for the engine at full power

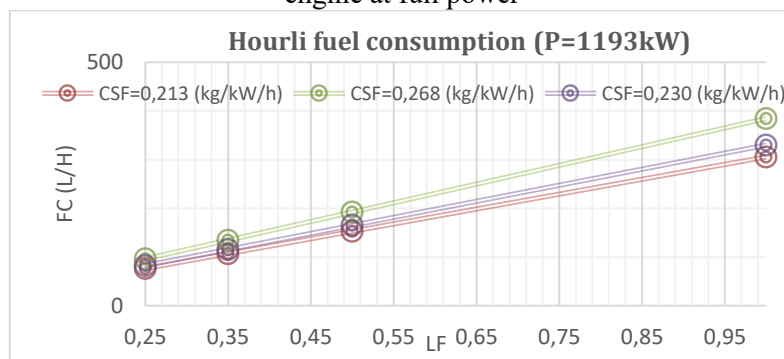

Figure 5 Fuel consumption FC (l/h) for engine load factor values (part of full power required by truck) LF = 0.25, 1.35, 0.5 and 1 for engine power P = 1193 (kW) and specific CSF fuel consumption for the engine at full power

Based on the collected and processed data, it was found out that the dump truck at the OP "Turija" worked in difficult working conditions, and the load factor of the LF engine had value of 45 to 50%. Liebherr developed a method for determining the truck fuel consumption per hour. According to this

method, the rate of fuel consumption is directly proportional to the delivered power [1]. Assuming that LF = 100%, the obtained fuel consumption would be 352.8 (l/h) for 1176 kW engine and 357.9 (l/h) for 1193 kW engine.

CO2 emission from burned fuel can be determined by an on-site measurement. However, the on-site measuring devices (units) that continuously monitor emission equipment can be expensive and require permanent maintenance (Mining Environmental Management, 2008). Another possibility is to determine CO2 emission using the mathematical equations [1].

CO2 emission from diesel fuel in (t/h) can be written as [1]: $CO_2 = FC \times CF$ where FC is diesel consumption (l/h) and CF is the conversion factor. CO2 emission conversion factors for diesel fuel can be calculated as: $CF = CC \times 10^{-6} \times 0.99 \times (44/12)$

where CC is the carbon content of diesel fuel (g/l) and 0.99 is the oxidation factor.

According to the Environmental Protection Agency (EPA, 2005), the conversion factor for CF diesel fuel is 0.00268. This factor is calculated on the basis of carbon residues in one liter of diesel. The carbon content of diesel is $CC = 733 \text{ g/l}$ (EPA, 2005). The oxidation factor for all oil and its products is 0.99. This practically means that 99% of the fuel burns, while 1% remains unoxidized [1].

3. DIESEL FUEL CONSUMPTION AND AMOUNT OF CARBON DIOXIDE EMISSIONS

Based on the data of the Operational Technical Preparation Service, the operating parameters of the BelAz dump truck with internal markings B-1 were calculated; B-2; B-4; B-5; B-6; B-7; B-8; B-9; B-10; B-11; B-15; B-16; B-17 and B-21. The BelAz dump trucks at the OP "Turija" transport both overburden and coal during their work. The average volume mass of the overburden in the solid state is $\rho_{rmj}=2.25 \text{ (t/m}^3\text{)}$, the average bulk density of the overburden in the loose state is $\rho_{rmj}=1.5 \text{ (t/m}^3\text{)}$, and the average looseness coefficient for overburden $krj=1.5$.

As an illustration of the calculated operating parameters of all dump truck individually, Table 4 and Figure 6 are highlighted for BelAz of internal code B-1.

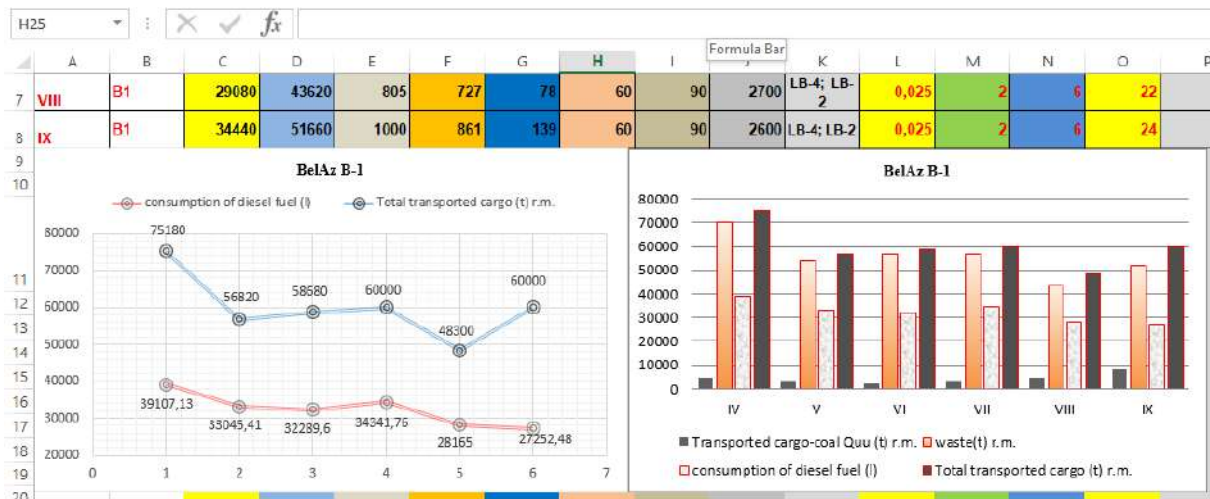

Figure 6 Transported cargo-coal (t) r.m., waste(t) r.m., total transported cargo (t) r.m. and consumption of diesel fuel (l) in IV, V, VI, VII, VIII and X months of BelAz internal code B-1

Figures 7 show the diesel fuel consumption (l) in IV, V, VI, VII, VIII and IX months of all BelAz at the open pit "Turija".

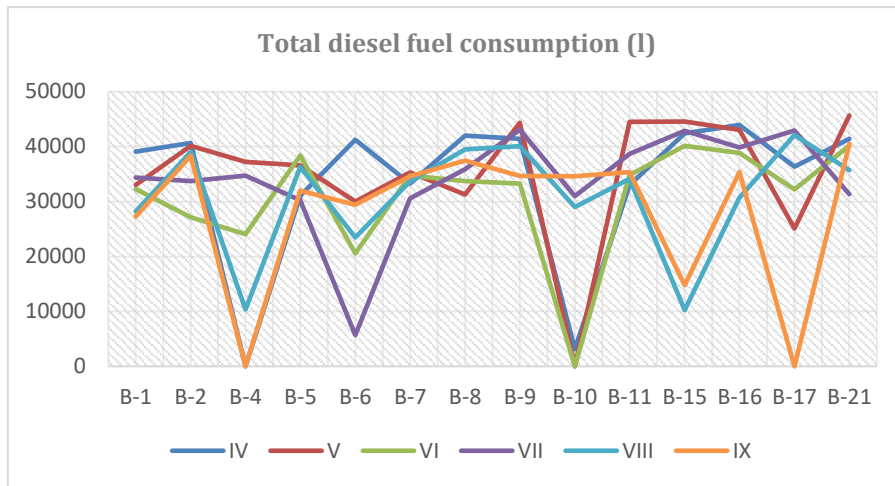

Figure 7 Total diesel fuel consumption (l) in IV, V, VI, VII, VIII and IX months

During six months of monitoring, the dump trucks traveled a total of 443692 (km). Analyzing the relationship between the amount of transported cargo and consumption of diesel fuel, it was found that in the same working conditions, the transport of a larger amount of cargo requires higher consumption of diesel fuel and vice versa. For the same amount of transported cargo, changes in working conditions affect the fuel consumption. Lack of auxiliary equipment and climatic conditions (precipitation, storm) cause the production to be difficult, so that even in the case of increasing the number of effective hours for transporting the same amount of cargo, leads to more fuel consumption, and it happens that more fuel is used for transport smaller amounts of cargo. In some cases, due to bad weather (heavy rain), it is necessary to move the dump truck to the other sites. Based on the collected data, the average consumption of diesel fuel was calculated per hour traveled (l/h), per kilometer traveled (l/km) and transported ton of loose tar (l/t r.m.), and shown in Figures 8 and 9.



Figure 8 Consumption of diesel fuel (l/h), (l/ km), (l/t r.m.) in the IV, V, VI, VII, VIII and IX months

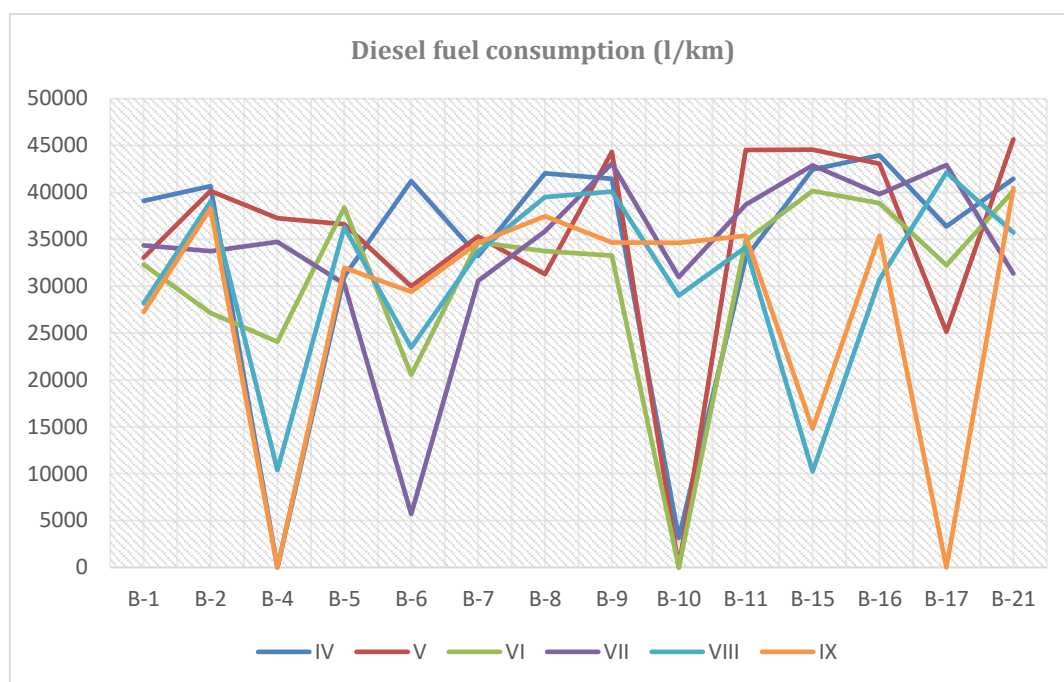

Figure 9 Consumption of diesel fuel per kilometer (l/ km) in the IV, V, VI, VII, VIII and IX months of the BelAz dump truck at the open pit “Turija”

Table 1 The average values of diesel fuel consumption per kilometer (l/km) for the IV, V, VI, VII, VIII and IX months of all BelAz dump trucks that were in operation

Month	Average diesel fuel consumption per kilometer traveled (l/km)
IV	6,065385
V	6,7125
VI	6,668333
VII	6,331538
VIII	6,126923
IX	5,118333

In the VII and VIII months, all dump trucks were working and the average monthly consumption of a BelAz dump truck ranged from 6.13 to 6.67 (l/km). Older BelAz trucks, driven by drivers with less experience, had the highest consumption in cargo transport, while relatively newer BelAz trucks used less fuel. With the BelAz B-8, the replacement of t engine showed a reduction in diesel fuel consumption, which was to be expected. The greatest impact on fuel consumption has the quality of road surface, weather conditions, and operation of auxiliary machinery. The transport of overburden took place to the inner western landfill with an average route length of 2500 m. Coal was loaded occasionally, and the average length of the route was 2500 m.

In order to determine the amount of carbon dioxide emission into the atmosphere, it is necessary to consider the consumption of diesel fuel in liters per hour. For each individual BelAz, diesel fuel consumption and CO₂ emission into the atmosphere were calculated.

Table 2 Diesel fuel consumption (l/h), average monthly working hours (h) and CO₂ emission into the atmosphere of the BelAz dump truck

month	B-1	B-2	B-4	B-5	B-6	B-7	B-8	B-9	B-10	B-11	B-15	B-16	B-17	B-21
<i>EmissionCO2 (t/h)</i>														
IV	0,46	0,44	0	0,47	0,45	0,45	0,44	0,46	0,44	0,43	0,42	0,42	0,45	0,42
V	0,5	0,51	0,49	0,46	0,52	0,5	0,44	0,5	0	0,47	0,49	0,49	0,49	0,46
VI	0,46	0,46	0,49	0,48	0,49	0,48	0,41	0,49	0	0,45	0,47	0,47	0,48	0,44
VII	0,48	0,49	0,49	0,48	0,58	0,49	0,46	0,47	0,45	0,48	0,47	0,47	0,48	0,46
VIII	0,49	0,47	0,48	0,48	0,46	0,44	0,43	0,47	0,44	0,46	0,48	0,48	0,48	0,45
IX	0,41	0,45	0	0,42	0,43	0,4	0,42	0,43	0,42	0,43	0,41	0,41	0,00	0,4
<i>Diesel fuel consumption (l/h)</i>														
IV	170,02	163,23	0	174,73	169,08	168,39	164,31	173,48	165,75	161,32	158,05	158,05	167,52	156,15
V	185,39	189,26	181,43	172,57	193,1	185,68	165,09	188,08	0	177,09	181,54	181,54	183,45	171,04
VI	171,12	172,47	181,52	177,86	182,88	179,31	152,63	183,97	0	168,79	176,32	176,32	178,01	163,29
VII	178,14	184,7	183,03	180,28	214,58	181,29	171,55	177,11	168,87	178,29	176,68	176,68	179,45	170,55
VIII	181,36	174,52	177,54	179,03	172,24	163,06	162,19	173,66	164,25	171,54	177,74	177,74	180,49	167,94
IX	154,44	166,25	0	156,64	159,26	149,81	156,31	159,03	155,16	160,22	154,52	154,52	0	149,82
<i>average monthly working hours (h)</i>														
IV	230,01	249,135	0	177,735	243,78	197,37	255,765	238,935	18,87	204,765	268,515	268,515	217,005	265,45
V	178,245	212,16	205,275	212,16	155,295	190,23	189,465	235,62	0	251,43	245,565	245,565	136,935	266,98
VI	188,7	157,335	132,6	215,73	112,455	193,545	221,085	180,795	0	206,55	227,715	227,715	181,05	246,07
VII	192,78	182,58	189,72	167,79	26,52	168,555	209,1	243,27	183,345	217,005	242,76	242,76	239,19	183,85
VIII	155,295	223,635	58,395	202,725	136,17	206,55	243,525	230,775	176,46	199,155	57,63	57,63	233,325	212,67
IX	176,46	230,52	0	204	184,62	231,03	239,7	218,025	223,125	220,83	95,88	95,88	0	270,04
<i>Total CO₂ emission (t)</i>														
IV	104,80	108,98	0	83,22	110,46	89,07	112,62	111,08	8,38	88,52	113,73	113,73	97,42	111,08
V	88,56	107,61	86,66	98,12	80,36	94,66	83,82	118,76	0	119,32	119,47	119,47	67,32	122,38
VI	86,53	72,72	91,79	102,83	55,11	93,00	90,43	89,13	0	93,43	107,60	107,60	86,37	107,68
VII	92,04	90,37	94,56	81,06	15,25	81,89	96,13	115,46	82,97	103,68	114,9	114,9	115,03	84,03
VIII	75,48	104,59	73,890	97,26	62,85	90,26	105,85	107,40	77,67	91,55	27,45	27,45	112,86	95,71
IX	73,04	102,71	0	85,63	78,79	92,75	100,41	92,92	92,78	94,82	39,70	39,70	0	108,42

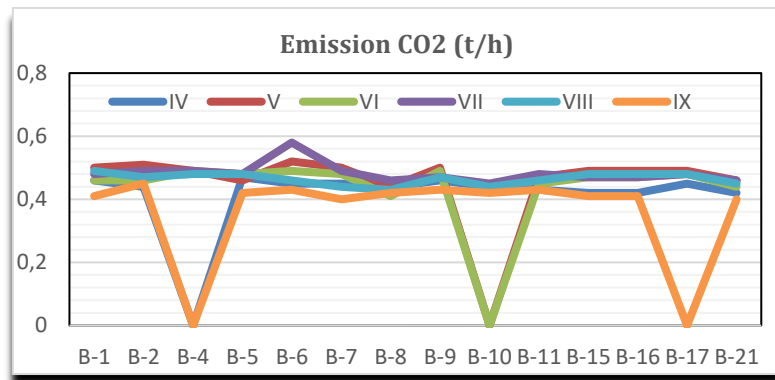

Figure 10 Emission of CO₂ (t/h) in the IV, V, VI, VII, VIII and IX month

In the IV month, the BelAz dump truck with the internal code B-4 was left out of consideration because it was not in operation. The B-5 dump truck had the highest amount of CO₂ emission (t/h) and the highest fuel consumption (l/h) this month, and the lowest B-15. In the V month, the largest amount of CO₂ (t/h) was emitted into the atmosphere by the B-4 dump truck, which had the highest fuel consumption (l/h) in this month, and the lowest B-8. In the VI month, the BelAz dump truck with the internal code B-10 was left out of consideration because it was not in operation. The highest amount of CO₂ (t/h) was emitted into the atmosphere by the B-9 dump truck, which had the highest fuel consumption (l/h) this month, and the lowest B-4. In the VII month, the largest amount of CO₂ (t/h) was emitted into the atmosphere by the B-6 dump truck, which had the highest fuel consumption (l/h) in this month, and the lowest B-10. In the VIII month, the largest amount of CO₂ (t/h) was emitted into the atmosphere by the B-1 dump truck, which had the highest fuel consumption (l/h) in this month, and the lowest B-8. In the IX month, the largest amount of CO₂ (t/h) was emitted into the atmosphere by the B-2 dump truck, which had the highest fuel consumption (l/h) in this month, and the lowest B-7.

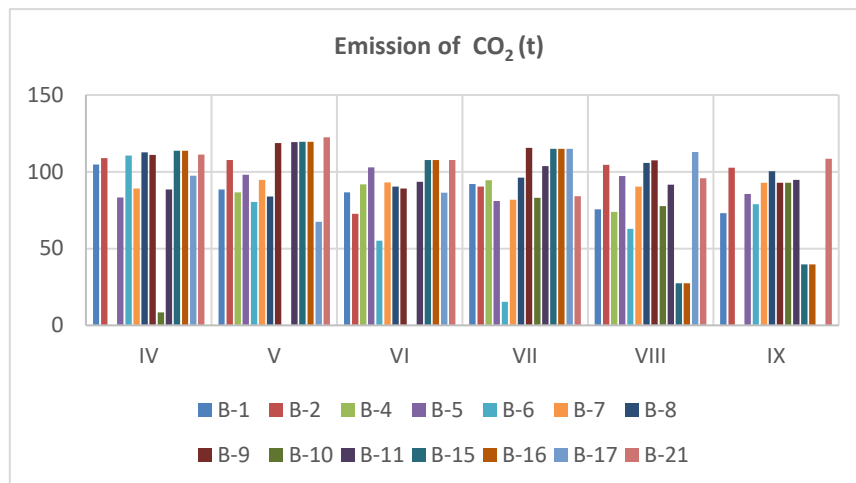

Figure 11 Total amount of emitted CO₂ (t) in the IV, V, VI, VII, VIII and IX month

The amount of carbon dioxide emitted into the atmosphere during a given month depends on the effective operating hours of the dump truck in that month. The average maximum amount of CO₂ (t) emitted during the six months ranged from 107.69 to 122.38 (t). During the two months when all the dump trucks were operating, it averaged from 112.86 to 112.86 (t).

4. PREVENTIVE MEASURES AND CHOICE OF MAINTENANCE STRATEGY TO REDUCE THE CARBON DIOXIDE EMISSIONS

Based on the findings after research, the suggestions can be made to improve and reduce fuel consumption, which directly affects the amount of carbon dioxide emissions released into the atmosphere. Fuel consumption is affected by the adequate maintenance and servicing of the BelAz dump trucks, so it is necessary to do it on time. Simplify access to the points for regular service, because this simplifies service and reduces the amount of time spent on regular maintenance procedures. Continue to check the tire pressure regularly as too low tire pressure impairs the lateral guidance of the tires, prolongs the braking distance and thus reduces driving safety. Also, a low tire pressure increases the rolling resistance, thereby increasing the fuel consumption. Checking the condition of tires and pressure in them is very important for safety and consumption. A tire is the only contact surface between a vehicle and ground, and has the task of withstanding carrying, movement, shock absorption, braking and acceleration, while rolling resistance has a direct impact on fuel consumption. Maintaining and improving the road surface can significantly reduce the fuel consumption. When designing, take into account the lengths of routes intended for transport and their slopes. Reducing the length of route and its slope allows for a shorter dump truck cycle and transport of larger quantities of cargo with lower fuel consumption. Provide a sufficient number of auxiliary machinery and equipment, and regular maintenance of the route. If possible, maintain a constant speed during transport. Apply an adequate organization of technological process, because it has a significant impact on the fuel consumption.

CONCLUSION

Many parameters, such as the age and vehicle maintenance, load, speed, cycle time, mine layout, work schedule, idle time, tire wear, rolling resistance, engine operating parameters and gear change patterns can affect the fuel consumption in the open pit exploitation. The fuel consumption of BelAz dump truck with the internal code B-1 was considered at the OP "Turija"; B-2; B-4; B-5; B-6; B-7; B-8; B-9; B-10; B-11; B-15; B-16; B-17 and B-21 during six months of observation. The amount of carbon dioxide emitted into the atmosphere during a given month depends on the effective operating hours of a dump truck in that month. The average maximum amount of CO₂ (t) emitted during the six months ranged from 107.69 to 122.38 (t). During the two months when all the dump trucks were operating, it averaged from 112.86 to 112.86 (t).

The average amount of CO₂ emitted per BelAz into the atmosphere over six months ranged from 0.17 to 0.29 (t/h). In the months when not all trucks were working, the total amount of CO₂ emitted ranged from 2.78 to 3.58 (t/h) on average.

During the two months when all the dumpers were working, it averaged 3.45 to 3.73 (t/h). For difficult working conditions and the length and background of the route, and slopes, we can expect the obtained average CO₂ emissions in irregular months, except for the winter period when diesel fuel consumption increases by 20%, and thus CO₂ emissions. Also, the consumption and emission of CO₂ is affected by adequate maintenance and servicing of the BelAz dump trucks, so it is necessary to do it on time.

Analyzing the results of the processed data, it was found that the fuel consumption in some months is directly proportional to the amount of transported cargo and amount of carbon dioxide emitted. For the same amount of transported cargo, changes in the working conditions affect the fuel consumption. A lack of auxiliary equipment and climatic conditions (precipitation, storm) cause production to be difficult. In the months when the technological process was difficult due to a lack of auxiliary machinery and equipment, the adverse weather conditions (storms or heavy rainfall), the fuel consumption was increased compared to a consumption in the stable operating conditions, as well as the carbon dioxide emissions. In such conditions, and in the case of an increase in the number of effective hours achieved for transport the same amount of cargo, the fuel consumption was higher for transport of less cargo.

Changes in the length of route as a result of moving the excavator to a new position and changes in the slope of route affected the change in fuel consumption and CO₂ emissions. Due to the increased length of transport route and inadequate organization of the technological process, poor working conditions, some dump trucks recorded higher fuel consumption when transporting smaller amounts of cargo.

Based on the collected and processed data of hourly fuel consumption for engines of 1193 (kW) and 1176 (kW), it can be concluded that the dump truck at the OP "Turija" worked in difficult working conditions. The highest CO₂ emissions from freight transport were in older BelAz, with over 70,000 engine hours, served by less experienced drivers, while relatively newer BelAz emitted less CO₂. With the BelAz B-8, the replacement of engine showed a reduction in diesel fuel consumption, which was expected.

The presented method of processing, analysis and extraction of important information on operating parameters and carbon dioxide emissions in this way was done for the first time in our area and can be repeated at the other open pits that use the dump trucks to transport cargo. The contribution of this paper to the professional literature is that for the first time a certain amount of CO₂ emitted by the BelAz at the open pit on the basis of collected data and method used. Determining the fuel consumption is used to determine the preventive measures and strategies for maintaining the transport system in order to reduce it, as well as the emission of exhaust gases into the atmosphere.

REFERENCES

1. V. Kecojević, D. Komljenović (2010) „Haul truck fuel consumption and CO₂ emission under various engine load conditions“, https://www.researchgate.net/publication/261214668_Haul_truck_fuel_consumption_and_CO2_emission_under_various_engine_load_conditions, 19.10.2020.
2. Ali Soofastaei (2016) „Efficiency of Haul Trucks in Surface Mines“, PhD Project, DOI:10.13140/RG.2.2.18587.67365, https://www.researchgate.net/publication/309176186_Development_of_an_Advanced_Data_Analytics_Model_to_Improve_the_Energy_Efficiency_of_Haul_Trucks_in_Surface_Mines, preuzeto 10.12.2020.
3. S. Mašić (1999) “Zbirka riješenih zadataka iz transporta u rudarstvu”, Rudarsko-geološko-građevinski fakultet, udžbenik, Univerzitet u Tuzli,
4. S. Hodžić, Sunčica Mašić (2005) „Zbirka riješenih zadataka iz kontinuiranog transporta u rudarstvu“, Rudarsko-geološko-građevinski fakultet, udžbenik, Univerzitet u Tuzli,
5. S. Hodžić, S. Mašić (2008) „Ciklični transport“ Rudarsko-geološko-građevinski fakultet, udžbenik, Univerzitet u Tuzli

-
6. J. Jamaković, S. Mašić (2022): “Carbon dioxide emission of a BelAz dump truck on an example of the open pit 'Turija' Brown Coal Mine Banovići”, Mining and Metallurgy Engineering Bor, UDC 622, ISSN 2334-8836 (Štampano izdanje) ISSN 2406-1395 (Online)
 7. J. Jamaković, S. Mašić (2021): “Fuel consumption of the BelAz dump trucks on an example of the open pit "Turija" of the brown coal mine Banovići”, Mining and Metallurgy Engineering Bor, UDC 622, ISSN 2334-8836 (Štampano izdanje) ISSN 2406-1395 (Online)
 8. Zakon o zaštiti okoliša, Sl. Novine FBiH, br .15/2021.
 9. https://www.researchgate.net/publication/309176186_Development_of_an_Advanced_Data_Analytics_Model_to_Improve_the_Energy_Efficiency_of_Haul_Trucks_in_Surface_Mines , preuzeto 10.12.2020.god.
 10. https://www.researchgate.net/publication/309176186_Development_of_an_Advanced_Data_Analytics_Model_to_Improve_the_Energy_Efficiency_of_Haul_Trucks_in_Surface_Mines , preuzeto 10.12.2020.god.